

## ELL-200-A



### **Installation Instructions**

ELL-200-A End of line lamp kit  
with cold applied connection technology  
for use with BARTEC PSB, MSB or HSB trace heaters

### **Consignes d'installation**

Kit voyant de bout de ligne ELL-200-A  
à technologie de connexion froide  
à utiliser avec les câbles chauffants de type BARTEC PSB, MSB ou HSB



<b>Table of contents</b>	
<b>Safety</b>	<b>2</b>
<b>Overview</b>	<b>3</b>
Compatibility	3
Certifications / Approvals	3
Technical data	3
<b>Trace heater specifications</b>	<b>4</b>
<b>Kit contents</b>	<b>5</b>
<b>Accessories</b>	<b>6</b>
<b>Installation</b>	<b>8</b>
Required tools	8
Cautions and warnings	8
Unrolling the trace heater	8
Installation on pipes	9
Fastening	9
Preparation of the trace heaters	10
Installation of the mounting stand	15
Installation of the junction box	16
Wiring	17
<b>Troubleshooting</b>	<b>19</b>
<b>Limited Product warranty</b>	<b>20</b>

## Safety

For safe installation and operation of the ELL-200-A End of line lamp kit the technical requirements and instructions given in this manual must be followed.

### WARNING

**Risk of fire or electrical shock. Follow these guidelines to avoid personal injury or material damage.**

- All electrical systems and installations must comply with BARTEC GmbH requirements and be installed in accordance with the relevant electrical codes and any other applicable national and local codes.
- BARTEC GmbH, the US and Canadian electrical codes require ground fault protection to be provided for all trace heating circuits.
- Note that the design guide that comes with each trace heater contains further important information and must be followed in addition to this manual.
- Install the connection kit, trace heaters and end seals carefully.
- Use the trace heater in accordance with the intended purpose and strictly comply with the operational data specified in section *Technical Data*.
- The bending radius of the trace heater must be at least 1" (25 mm). Do not bend on the narrow axis.
- Any defective component of the kit must be replaced before installation.
- To avoid short circuits, do not connect the trace heater bus wires together.
- Keep all components and the trace heaters dry before and during installation.
- This kit contains silicone adhesive. Keep out of reach of children. Store at below 77°F (25°C). Follow the safety instructions given on the packaging.
- Keep these instructions for future reference. If applicable, leave them with the end user.
- De-energize before installation or servicing.
- Use only original BARTEC accessories

### NOTICE

The following instructions are provided in English only. Refer to [www.bartec.us](http://www.bartec.us) for the French version.

## Sécurité

Afin de garantir la sécurité lors de l'installation et de l'utilisation du Kit voyant de bout de ligne ELL-200-A, il est impératif de respecter les exigences ainsi que les consignes techniques mentionnées dans le présent manuel.

### AVERTISSEMENT

**Risque d'incendie ou d'électrocution. Suivez ces consignes pour éviter toute blessure ou dommage matériel.**

- Tous les systèmes et installations électriques doivent satisfaire aux exigences imposées par la société BARTEC GmbH et doivent être installés conformément aux normes électriques en vigueur ainsi qu'aux autres prescriptions nationales et locales applicables.
- La société BARTEC GmbH ainsi que les normes électriques américaines et canadiennes imposent une protection contre les défauts à la terre pour tous les circuits de traçage électrique.
- Notez que le guide de conception fourni avec chaque câble chauffant contient des informations importantes additionnelles qu'il convient de respecter en plus du présent manuel.
- La pose du kit de raccordement, des câbles chauffants et des embouts d'étanchéité doit être réalisée avec soin.
- Utilisez le câble chauffant conformément à l'usage prévu et en respectant les caractéristiques de fonctionnement spécifiées à la section *Caractéristiques techniques*.
- Le rayon de courbure du câble chauffant ne doit pas être inférieur à 1" (25 mm). Ne pas courber le câble chauffant sur la tranche.
- Tout élément défectueux dans le kit doit être remplacé avant l'installation.
- Pour éviter un court-circuit, ne jamais raccorder ensemble les deux conducteurs du câble chauffant.
- Conservez tous les éléments et les câbles chauffants au sec avant et pendant l'installation.
- Ce kit contient de la colle silicone. Tenir hors de portée des enfants. Stocker à une température inférieure à 77°F (25°C). Respectez les consignes de sécurité indiquées sur l'emballage.
- Conservez ces instructions pour un usage ultérieur. Le cas échéant, remettez-les à l'utilisateur final.
- Mettre hors tension avant toute installation ou opération de maintenance.
- Utilisez exclusivement des pièces et accessoires d'origine BARTEC.

### AVIS

Les instructions qui suivent sont fournies en anglais uniquement. Veuillez vous référer au site [www.bartec.us](http://www.bartec.us) pour la version française.

## Overview

This manual introduces the installation and operation of the BARTEC ELL-200-A end of line lamp kit.

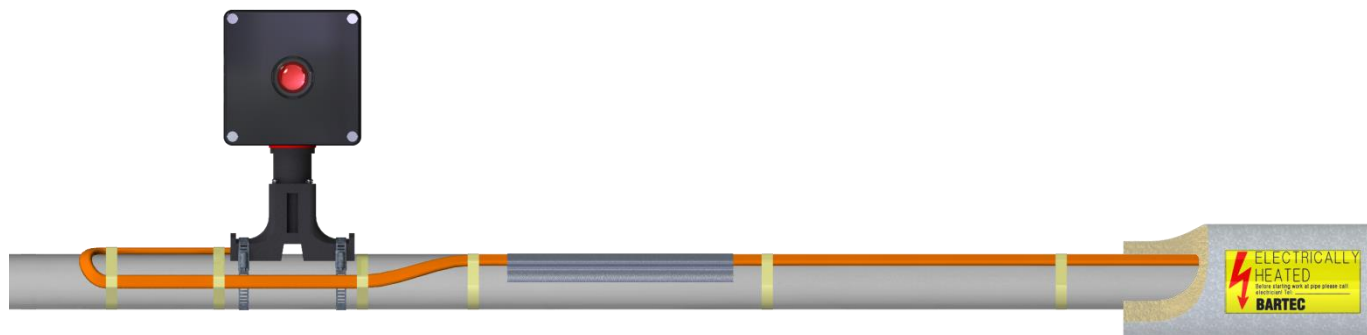

The trace heating system uses a self-regulating trace heater. It features a temperature-dependent resistive element that regulates and limits the heat according to the ambient temperature. If the ambient temperature rises, the power output of the trace heater is reduced. This self-regulating property prevents overheating which would cause damage to the trace heater. Even crossing or overlapping with other trace heaters (or other portions of the same trace heater) are possible.

The heating system is set up as a fixed equipment heating system for pipes in ordinary and hazardous areas. Thanks to the parallel design the trace heater can be cut and installed to any required length (up to the maximum heating circuit length as shown in the according design guide).

## Compatibility

The manual applies for the following trace heaters:

- BARTEC PSB
- BARTEC MSB
- BARTEC HSB

The following terms describe the parts of the trace heater within these instructions:

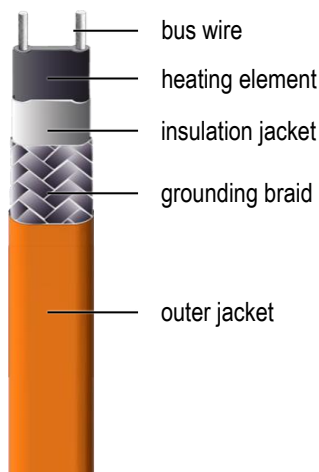

## Certifications / Approvals



ELL-200-A End of line lamp kit for BARTEC PSB, MSB or HSB trace heaters

## Technical data

<b>Ambient temperature range</b>	-40°F to 131°F / -40°C to 55°C
<b>Min. installation temperature</b>	-67°F / -55°C
<b>Power supply</b>	max. 277 Vac
<b>Protection classification</b>	Class I, Div 2 Group A, B, C, D Class II, Div 2 Group E, F, G Class III
<b>Ingress protection</b>	NEMA Type 4X / IP65
<b>Terminals</b>	Spring clamp Ex e; 3x2 PE

**Trace heater specifications**

Different types of BARTEC self-regulating trace heaters are available to suit the individual demands of your application. The following table provides the technical data for each trace heater family:

		<i>Trace heater specifications</i>		
		<i>PSB</i>	<i>MSB</i>	<i>HSB</i>
<b>Maximum exposure temperature <i>power on</i></b>		149 °F / 65 °C	230 °F / 110 °C	248 °F / 120 °C
<b>Maximum exposure temperature <i>power off</i></b>		185 °F / 85 °C	266 °F / 130 °C	374 °F / 190 °C
<b>Minimum operation temperature</b>		-76 °F / -60 °C	-76 °F / -60 °C	-76 °F / -60 °C
<b>Minimum installation temperature</b>		-40 °F / -40 °C	-40 °F / -40 °C	-40 °F / -40 °C
<b>Power output<sup>1</sup></b>		3 to 10 W/ft / 10 to 33 W/m	3 to 20 W/ft / 10 to 60 W/m	5 to 20 W/ft / 15 to 60 W/m
<b>Supply voltage</b>		max. 277 Vac	max. 277 Vac	max. 254 Vac
<b>Braid resistance / Minimum percent coverage</b>		< 18.2 Ω/km / > 70 %	< 18.2 Ω/km / > 70 %	< 18.2 Ω/km / > 70 %
<b>Braid material</b>		Tinned copper	Nickel-plated copper	Nickel-plated copper
<b>Minimum bending radius</b>		1" / 25 mm (Do not bend on the narrow axis.)	1" / 25 mm (Do not bend on the narrow axis.)	1" / 25 mm (Do not bend on the narrow axis.)
<b>Cable weight</b>		78.8 lb/100 ft / 10.9 kg/100 m	90.364 lb/100 ft / 12.5 kg/100 m	90.364 lb/100 ft / 12.5 kg/100 m
<b>Heater dimensions</b>	<i>fluoropolymer outer jacket</i>	0.45" x 0.22" / 11.6 x 5.6 mm	0.40" x 0.19" / 10.2 x 4.8 mm	0.40" x 0.19" / 10.2 x 4.8 mm
	<i>polyolefin outer jacket</i>	0.46" x 0.23" / 11.8 x 5.8 mm	n/a	n/a
<b>Temperature classes ("T-Ratings")</b>		3, 5 W/ft / 10, 15 W/m → T6 8, 10 W/ft / 25, 33 W/m → T5	3, 5 W/ft / 10, 15 W/m → T4 10, 15, 20 W/ft / 30, 45, 60 W/m → T3	5, 10, 15 W/ft / 15, 30, 45 W/m → T3 20 W/ft / 60 W/m → T2

**NOTICE**

If you want to use plastic piping within your installation, contact your local BARTEC distributor for verification that the design does not exceed the maximum withstand temperature of the pipe material. Also, adjustments in heat loss calculations may be required.

**AVIS**

Si vous souhaitez utiliser de la tuyauterie en plastique dans votre application, veuillez contacter votre distributeur BARTEC local afin de lui faire vérifier que la température maximale supportable ne soit pas excédée. De plus, des adaptations des calculs de perte de chaleur peuvent s'avérer nécessaires.

<sup>1</sup> nominal heat output at 10 °C

## Kit contents

The following table lists the kit contents of the ELL-200-A End of line lamp kit:

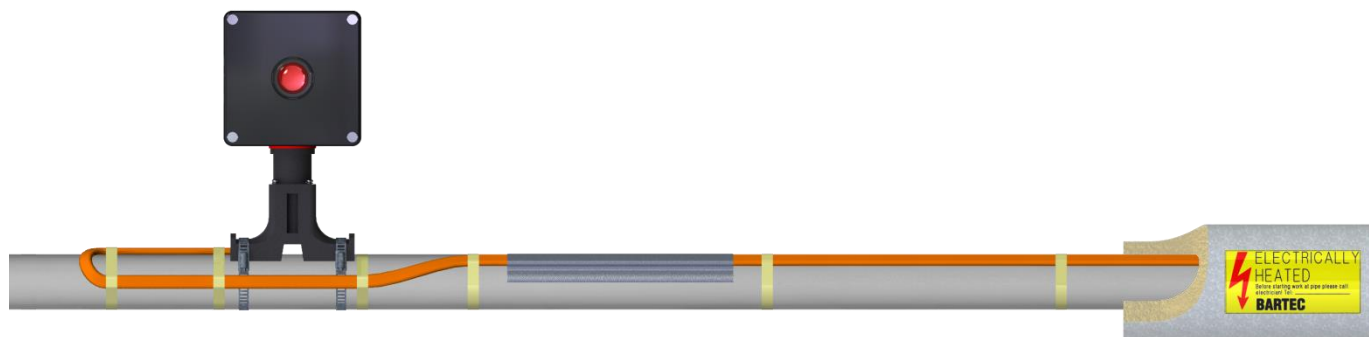

ELL-200-A End of line lamp kit

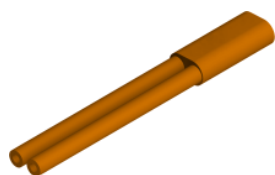

1 x  
Silicone pants



1 x  
End seal  
(not needed for ELL-kits)

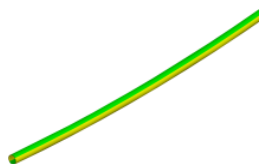

1 x  
Green/yellow tube  
for grounding braid



3 x  
Ferrule



1 x  
Silicone adhesive



1 x  
Trace heater  
grommet



1 x  
Blind plug



1 x  
Cover for junction box  
incl. 4 fixing screws



1 x  
Junction box with lamp module and  
grounding terminal

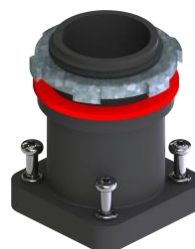

1 x  
Top unit of the mounting stand  
incl. sealing ring and lock nut





1 x  
Base unit of the mounting stand

# ELL-200-A End of line lamp kit Installation Instructions

## Accessories

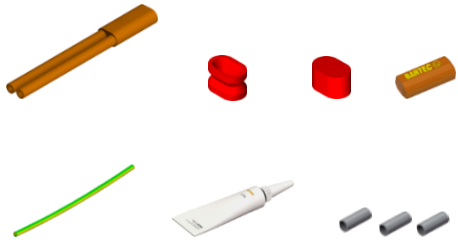
The following accessories are available for the ELL-200-A End of line lamp kit.

	<p><b>On pipe cable gland kit and end seal</b>                  spare parts kit for replacement of damaged or lost parts</p>	<p>Catalog No.: CAK-D5-A</p>
---	--	------------------------------

	<p><b>Polyester adhesive tape</b>                  for use on pipes other than stainless steel</p> <p><i>3/4" x 164 ft (50 m) per roll</i>  <i>Minimum installation temperature (dry surface): 40 °F (5 °C)</i>  <i>Maximum withstand temperature: 212 °F (100 °C)</i></p>	<p>Catalog No.: PT-164                  Order No.: 100706                  Part No.: 02-5500-0005</p>
---	--	---

Tip: Refer to the following table to estimate the required number of tape rolls for your installation:

Pipe diameter in inch (DN)	1/4" (DN8)	1/2" (DN15)	3/4" (DN20)	1" (DN25)	1 1/4" (DN32)	1 1/2" (DN40)	2" (DN50)	2 1/2" (DN65)	3" (DN80)	4" (DN100)	6" (DN150)	8" (DN200)	10" (DN250)	12" (DN300)	14" (DN350)	16" (DN400)	18" (DN450)	20" (DN500)	24" (DN600)
Required no. of tape rolls per 100 ft (30 m) of piping	1	1	1	1	1	1	2	2	2	3	4	5	6	7	7	8	9	10	12

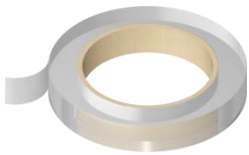
	<p><b>Glass cloth tape</b>                  for attaching self-regulating trace heaters on all pipes including stainless steel / required during preparation of power limiting trace heaters</p> <p><i>1/2" x 108 ft (33 m) per roll</i>  <i>Minimum installation temperature (dry surface): 15 °F (-10 °C)</i>  <i>Maximum withstand temperature: 392 °F (200 °C)</i></p>	<p>Catalog No.: GT-108                  Order No.: 100306                  Part No.: 02-5500-0047</p>
---	--	---

Tip: Refer to the following table to estimate the required number of tape rolls for your installation (for attaching trace heaters on pipes only)

Pipe diameter in inch (DN)	1/4" (DN8)	1/2" (DN15)	3/4" (DN20)	1" (DN25)	1 1/4" (DN32)	1 1/2" (DN40)	2" (DN50)	2 1/2" (DN65)	3" (DN80)	4" (DN100)	6" (DN150)	8" (DN200)	10" (DN250)	12" (DN300)	14" (DN350)	16" (DN400)	18" (DN450)	20" (DN500)	24" (DN600)
Required no. of tape rolls per 100 ft (30 m) of piping	1	1	1	1	2	2	2	3	3	4	5	7	9	10	11	12	14	15	18



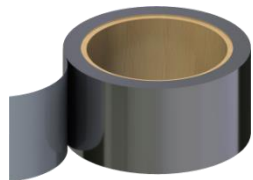

### Aluminum adhesive tape

for use on all pipe materials

2" x 164 ft (50 m) per roll

AT80:

Minimum installation temperature (dry surface): 40 °F (5 °C)

Maximum withstand temperature: 176 °F (80 °C)

AT150:

Minimum installation temperature (dry surface): 40 °F (5 °C)

Maximum withstand temperature: 302 °F (150 °C)

Tip: The required number of tape rolls per 100 ft (30 m) of pipe is 0.6.

AT80:

Catalog No.: AT80-164

Order No.: 100506

Part No.: 02-5500-0003

AT150:

Catalog No.: AT150-164

Order No.: 101606

Part No.: 02-5500-0014



### Stainless steel pipe straps

stainless steel, for attaching mounting stands on pipes etc. No special tooling required.

for pipe  $\varnothing$  up to 3" / DN80:

Catalog No.: PC-1

Order No.: 435727

for pipe  $\varnothing$  up to 10" / DN250:

Catalog No.: PC-2

Order No.: 435729



### Electrically traced warning label

Warning label for trace heater circuits

Recommended: electrical warning label every 10 ft. (3 m) on the outside of the thermal cladding on a clearly visible place.

Packaged in rolls of 100 pieces

English:

Catalog No.: HTWL-US

Order No.: 113550

Part No.: 05-2144-0047

French:

Catalog No.: HTWL-FR

Order No.: 120300

Part No.: 05-2144-0703

## Installation

### Required tools

The following tools are required for installation of the ELL-200-A End of line lamp kit:

- Wire cutters
- Flat screwdriver
- Cross-head screwdriver
- Electricians screwdriver
- Tape measure
- Utility knife
- Needle-nose pliers (2x)
- Tongue and groove pliers
- Crimping pliers



1

### Cautions and warnings

#### **⚠ WARNING**

Risk of fire or electrical shock. De-energize all power circuits before installation or servicing. Always use ground fault equipment within the heat tracing system.

#### **⚠ AVERTISSEMENT**

Risque d'incendie ou d'électrocution. Mettre tous les circuits électriques hors tension avant toute installation ou opération de maintenance. Toujours utiliser un dispositif de protection contre les défauts à la terre au sein du système de traçage électrique.

- Double-check that all power circuits are de-energized before you begin your work.
- Make sure that you do not exceed the maximum heating circuit length for the trace heater type you use. Refer to the design guide of the heating system.



2

### Unrolling the trace heater

#### **⚠ WARNING**

Risk of short cuts and/or material damage. Keep the trace heater ends dry before and during installation. Observe the design guide of the trace heating system.

#### **⚠ AVERTISSEMENT**

Risque de court-circuit et/ou de dommages matériels. Conservez les extrémités du câble chauffant au sec avant et pendant toute la durée de l'installation. Respectez les indications fournies dans le guide de conception du système de traçage.

- Unroll the required trace heater in a straight line and cut to the correct length. Cut off the trace heater ensuring a straight cut.
- Do not bend or pinch the trace heater or pull it over sharp edges.

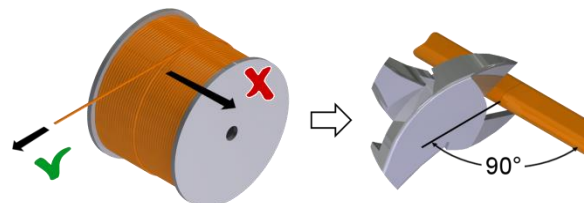

3

## Installation on pipes

This step is necessary for plastic pipes only since plastic pipes conduct heat less efficiently than metal pipes do. For metal pipes continue with step 5.

- Place aluminium tape where the trace heater will be attached for better heat distribution.

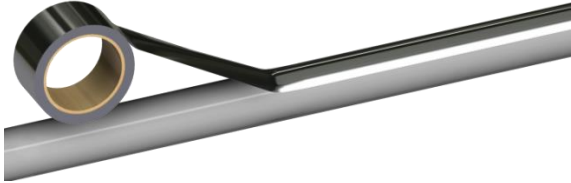

4

## ⚠ CAUTION

Risk of injury and/or material damage. Never tread on or drive over the trace heater. Do not use it as a loop for stepping on.

## ⚠ ATTENTION

Risque de blessures et/ou de dommages matériels. Ne pas marcher ni rouler sur le câble chauffant. Ne pas s'en servir comme cordage.

- Preferably install the trace heater in a straight line along the pipe. This saves time, helps to avoid installation mistakes and prevents damage to the trace heater during the thermal insulation work. Furthermore the trace heater can be easily located later on.



- The trace heater should be installed spirally only if this is expressly specified in the project planning.



## NOTICE

When installing allow for an additional length of trace heater for assembling splice connections, tee branches, end seals etc. (approx. 1.6 ft (0.5 m) for each).

## AVIS

Lors de la pose, réservez une longueur additionnelle de câble chauffant pour l'assemblage des jonctions de fil, des dérivation en T, embouts d'étanchéité, etc. (env. 1,6 ft (0,5 m) dans chaque cas).

5

- Preferably install the trace heater in the lower half of the pipe, but **not on the lowest point**. This prevents mechanical damage and allows for better heat distribution.
- If you use multiple trace heaters, position them with an offset of 90°.

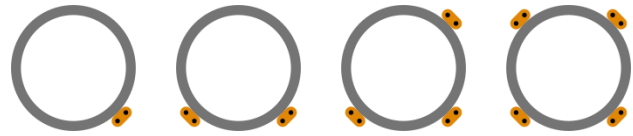

6

## Fastening

At first, select the correct fastening material:

- Always use polyester adhesive tape or glass cloth tape that suits the expected temperatures.
- Preferably use BARTEC adhesive tapes.
- Never use PVC insulating tape or self-adhesive tapes containing PVC or VC.
- Do not use metal wire or banding.



7

- Fasten the trace heater with the adhesive tape or zip ties at intervals of at least 12" (300 mm) on plastic pipes or 36" (900 mm) on steel pipes.

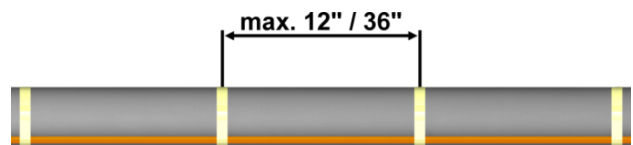

## NOTICE

In order to ensure good heat transmission the trace heater must have a flat, flush fit over the whole length. If necessary, reduce the distances between the fixing points.

## AVIS

Pour assurer une bonne conduction thermique, le câble chauffant doit être posé bien à plat et bien au contact de la tuyauterie sur toute la longueur. Au besoin, réduisez l'écartement entre les points d'attache.

8

**Preparation of the trace heaters**

- Pass the trace heater through the base unit of the mounting stand.
- Do not fix the mounting stand on the pipe yet.

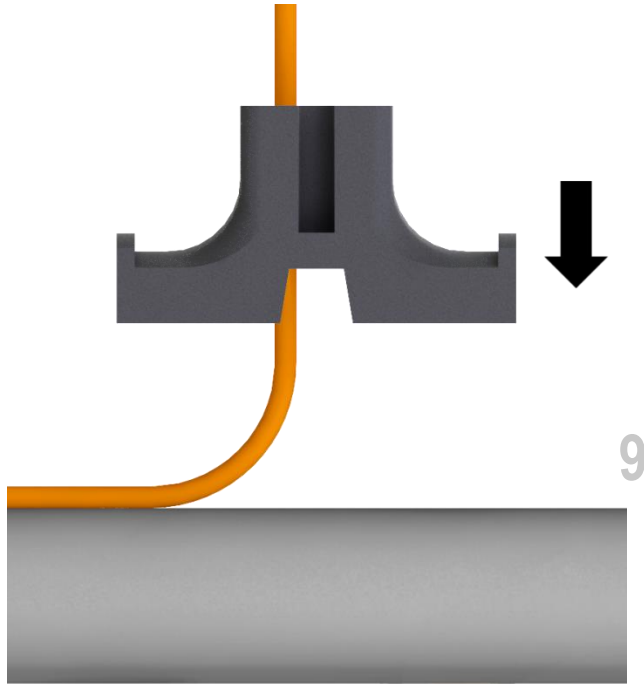

- Slide the trace heater grommet onto the trace heater and into the seal seat.
- Slide the blind plug into the free seal seat.
- Make sure that the trace heater stands out approximately 10" (25 cm). This makes cable preparation easier.

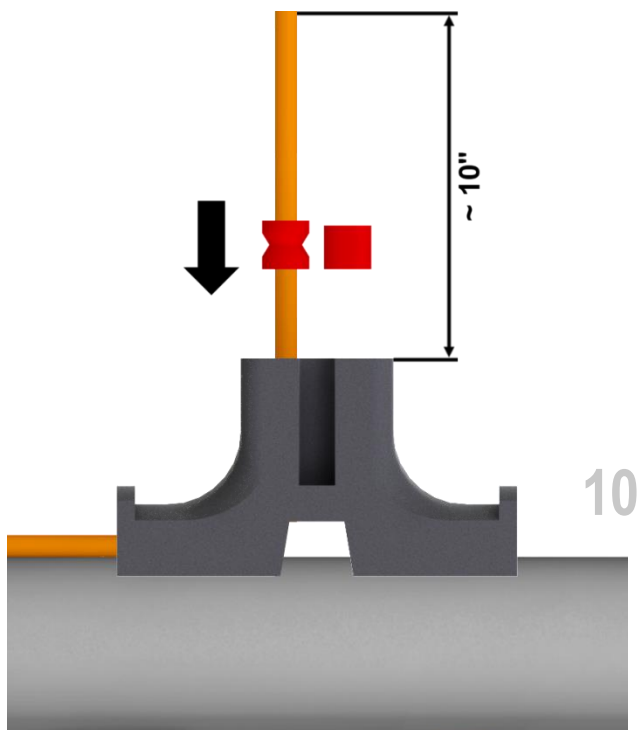

- Slide the top unit of the mounting stand over the trace heater.
- Slightly tighten the 4 fixing screws using a crosshead screwdriver. Do not tighten them fully yet to allow the trace heater to be moved.

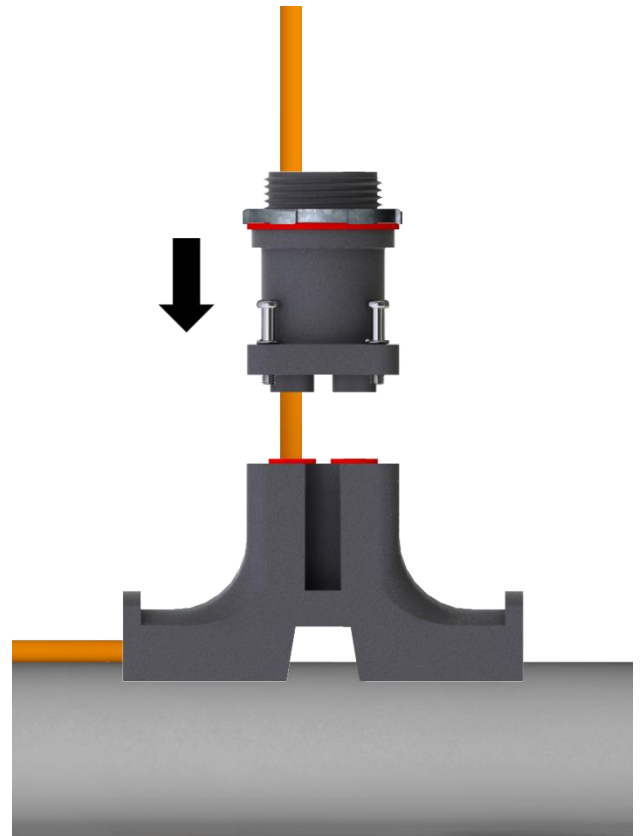

- Remove 5 3/4" (145 mm) of the outer jacket on the end of the trace heater.

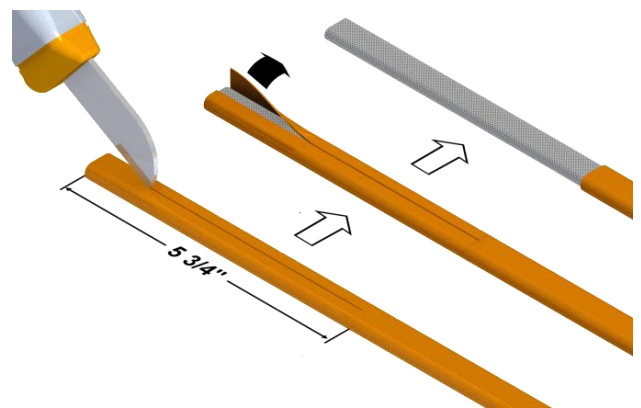

- Push the grounding braid back. Use the screwdriver to form an eyelet. Be careful not to damage the internal insulation jacket.

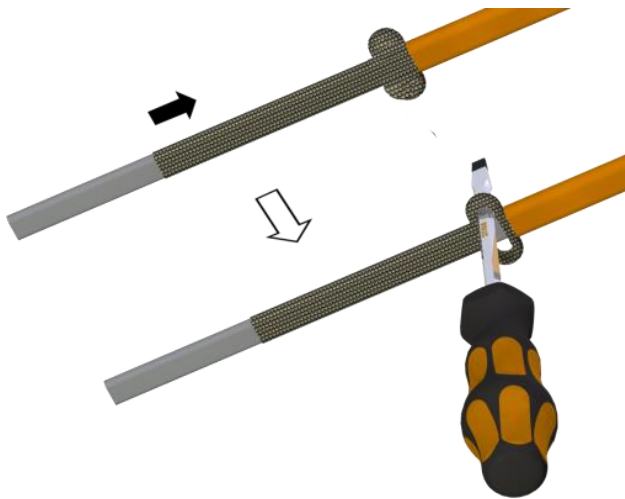

13

- Push the green/yellow tube onto the twisted grounding braid.

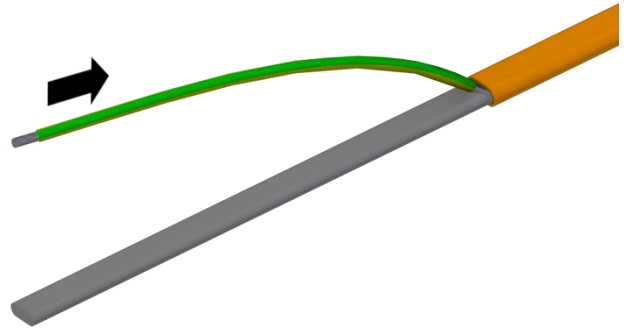

16

- Bend the trace heater and pull the heating element out of the grounding braid.

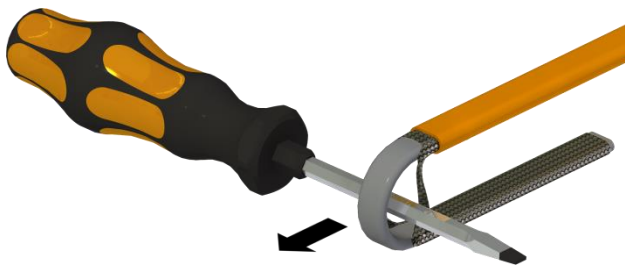

14

- Twist the grounding braid in order to form a pigtail.



15

- Remove 4 1/2" (115 mm) of the internal insulation jacket. Take care not to damage the bus wires.

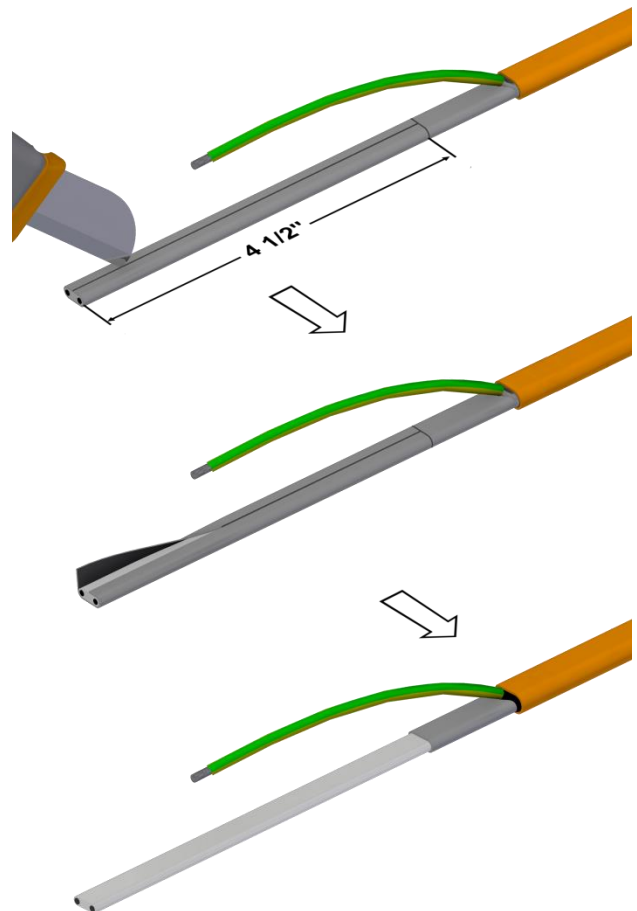

17

- Make a small cut **over and under** each bus wire. Take care not to damage the bus wires.
- Carefully make an incision into the edges of the heating element. Take care not to damage the bus wires.

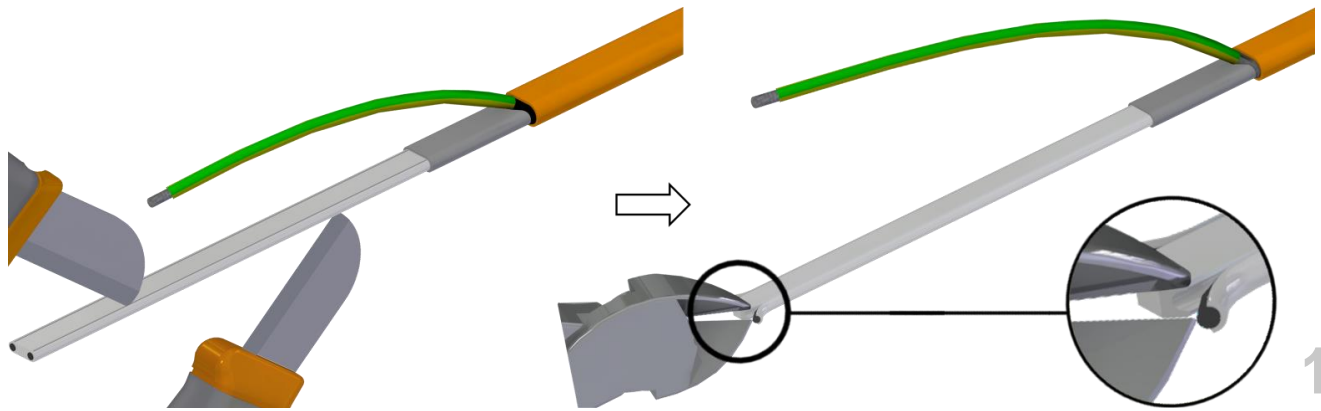

- Pull off the bus wires while holding the heating element.

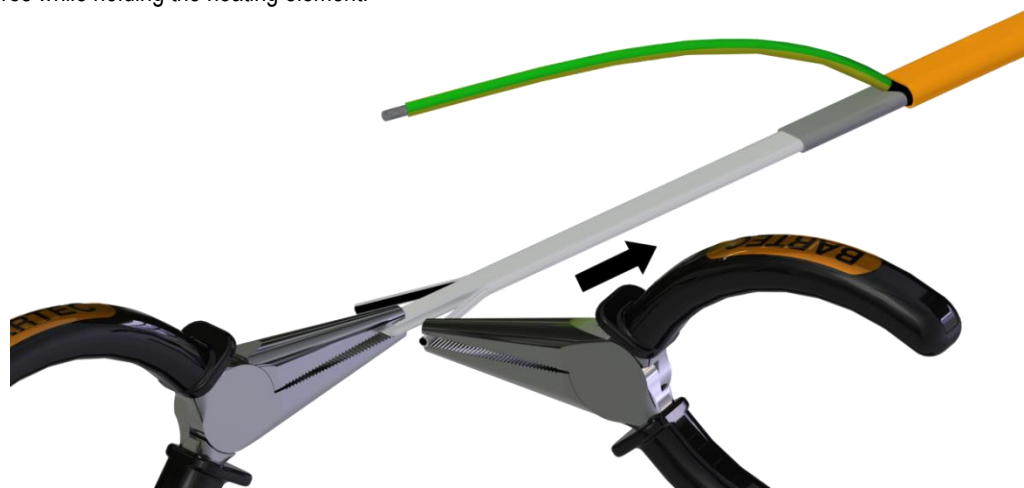

- Remove any remaining heating element that sticks to the bus wires.

## ⚠ CAUTION

Risk of malfunction of the heating system. Before you continue, make sure that the bus wires are intact and not nicked or damaged.

## ⚠ ATTENTION

Risque de dysfonctionnement du système de traçage. Avant de continuer, assurez-vous que les fils conducteurs sont intacts, qu'ils ne sont pas incisés ni endommagés.

- Twist the bus wires.

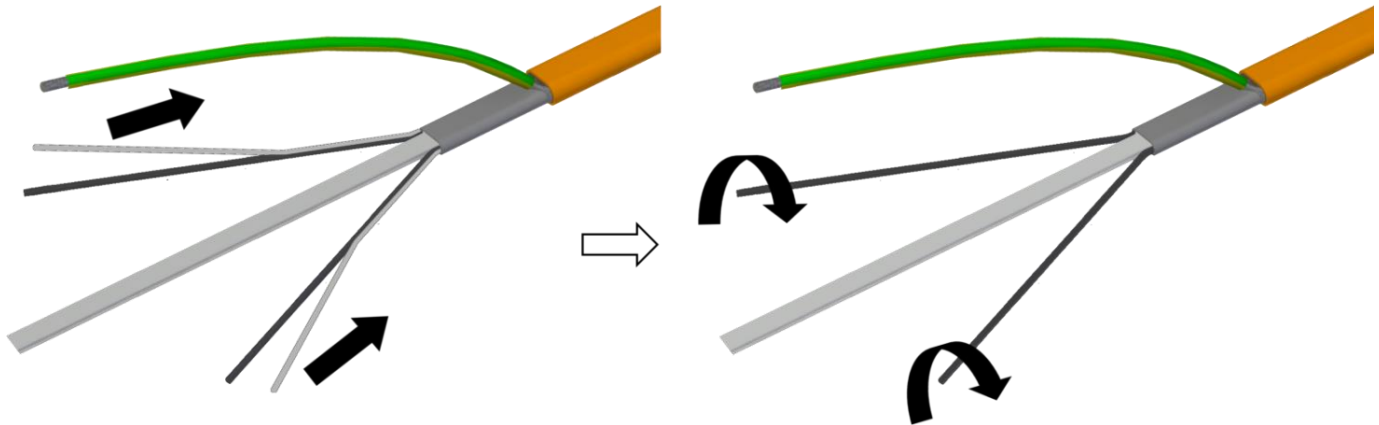

20

- Remove the remaining heating element. Take care not to damage the bus wires.



21



- Carefully cut in a triangle (1/4" / 5 mm) between the bus wires. Take care not to damage the bus wires.

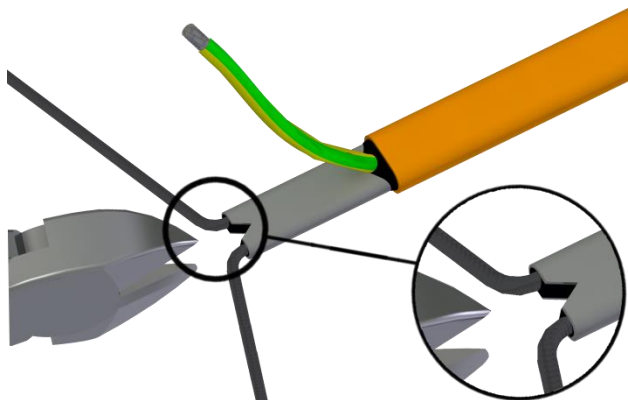

22

- Thread the bus wires into the silicone pants.
- You might add further silicone adhesive to ensure optimal sealing.
- Slide the silicone pants all the way onto the heating element.

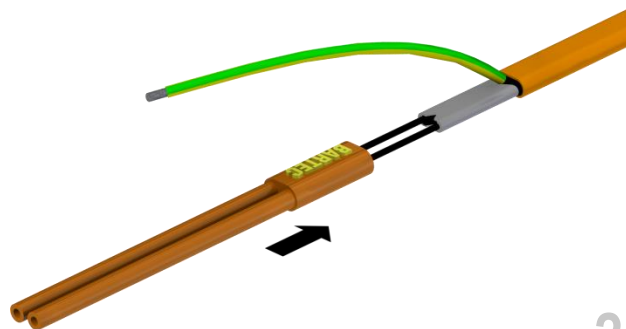

24

**⚠ CAUTION**

The silicone adhesive may cause irritation to skin and eyes. Avoid eye contact. Avoid repeated or prolonged skin contact. In case of contact with eyes, rinse with water and seek medical advice.

**⚠ ATTENTION**

La colle silicone peut irriter la peau et les yeux. Eviter tout contact avec les yeux. Eviter tout contact répété ou prolongé avec la peau. En cas de contact avec les yeux, rincer abondamment à l'eau claire et consulter un médecin.

- Put silicone adhesive onto the exposed heating element and insulation jacket.

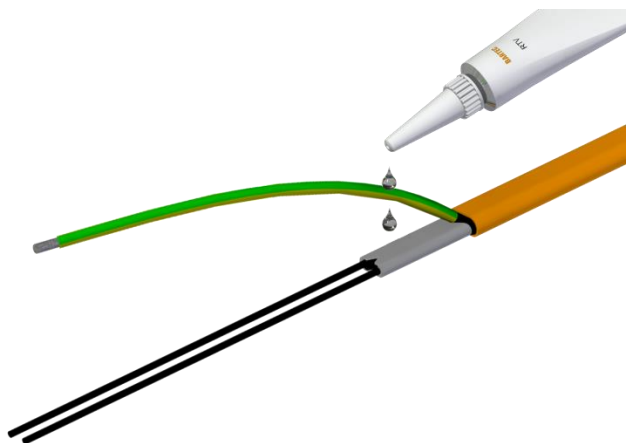

23

- Crimp a ferrule onto the twisted grounding braid.

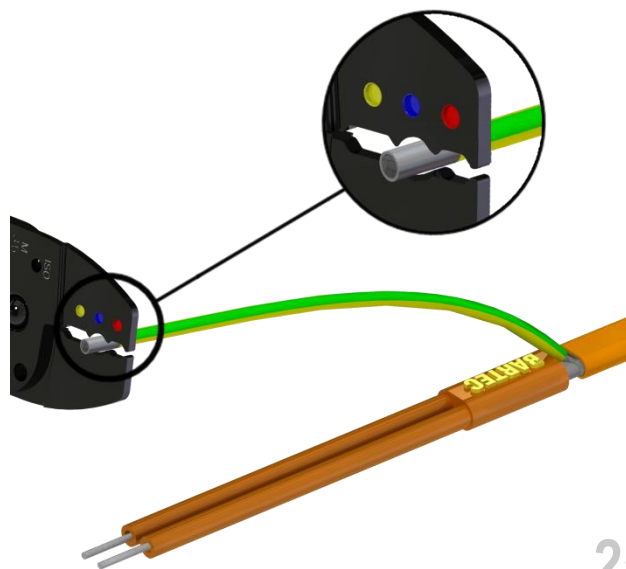

25

- Crimp a ferrule onto each of the bus wires.

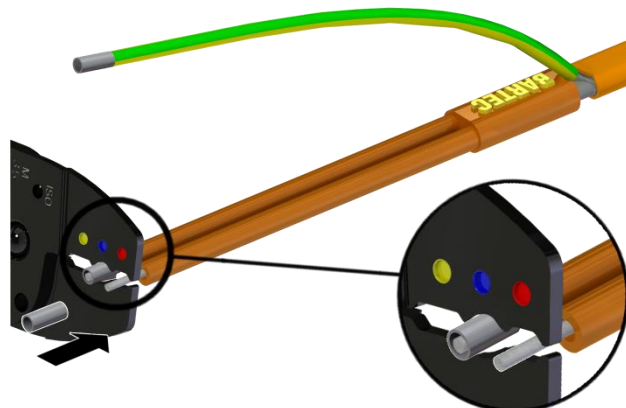

26



## Installation of the mounting stand

- Pull back the trace heater. For easy cable connection it is enough when the silicone pants stands out of the mounting stand.

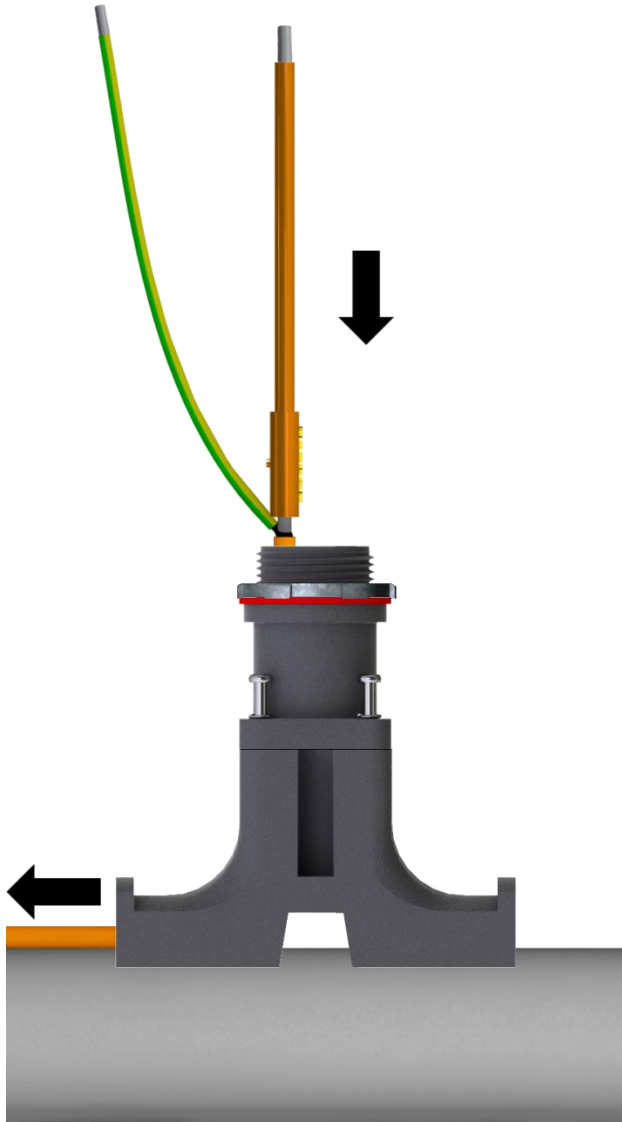

27

- Now, tighten the 4 fixing screws of the top unit of the mounting stand using a cross-head screwdriver.

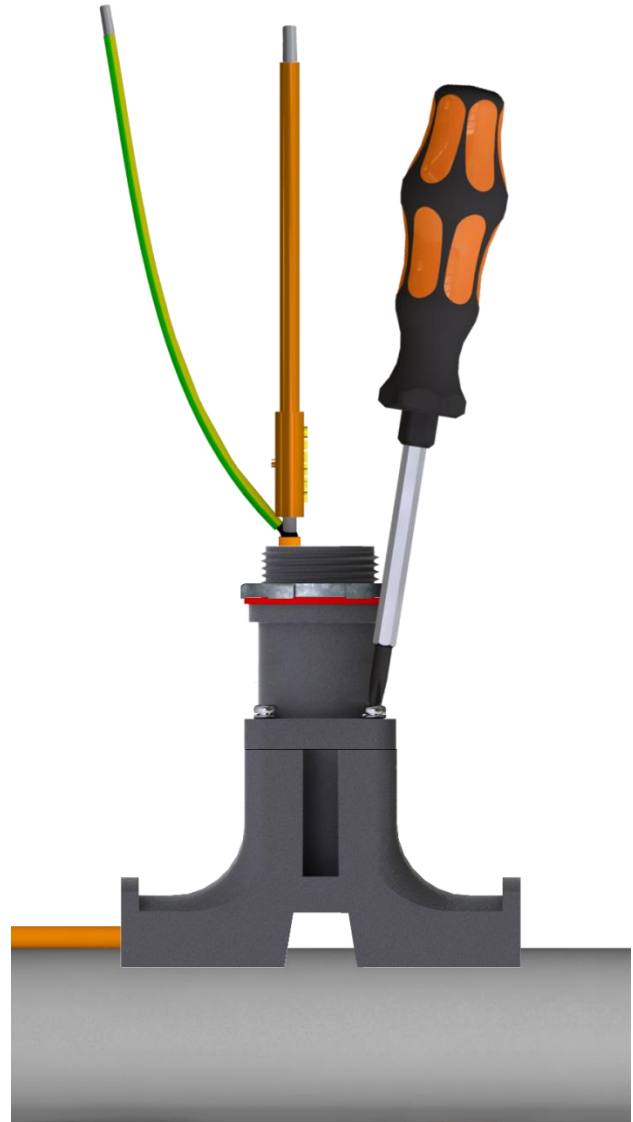

28

- Install the pipe straps and tighten them firmly using a screwdriver.

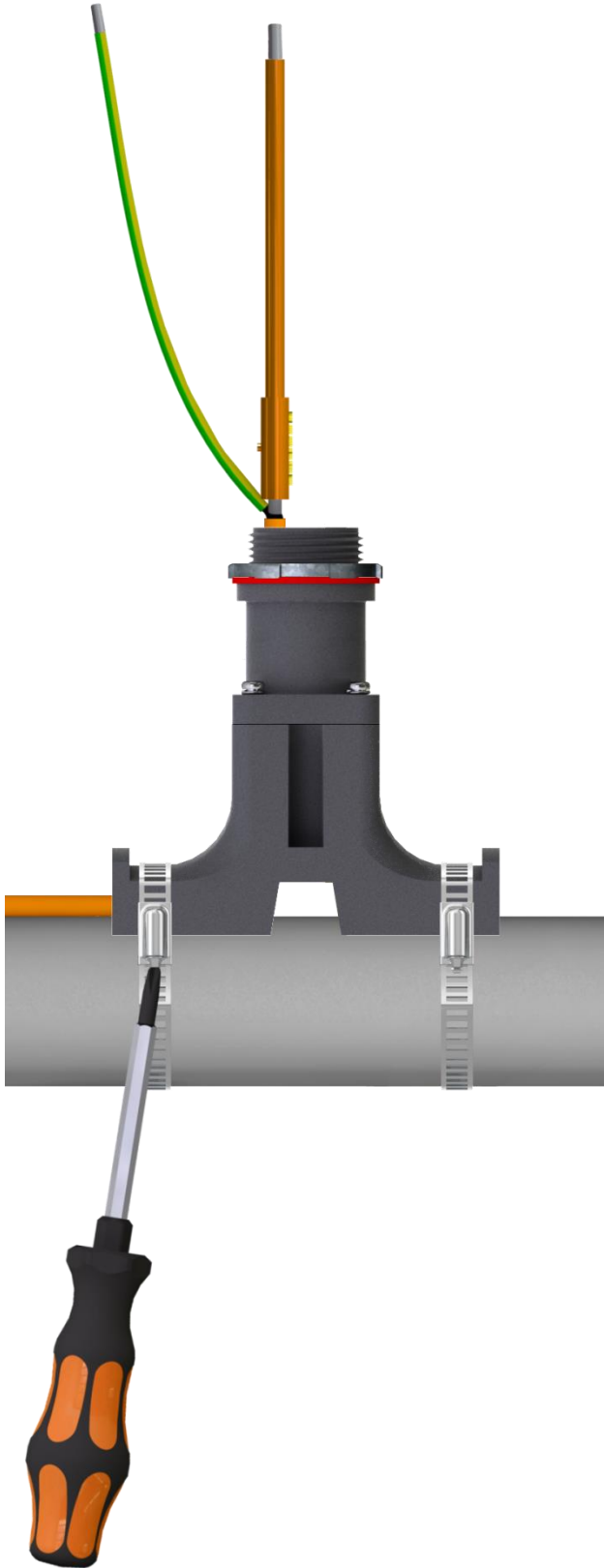

29

#### Installation of the junction box

- Unscrew the lock nut of the top unit of the mounting stand.
- Feed the prepared trace heater into the junction box.
- Slide the junction box onto the top unit of the mounting stand.
- Install the lock nut and tighten it using tongue and groove pliers.

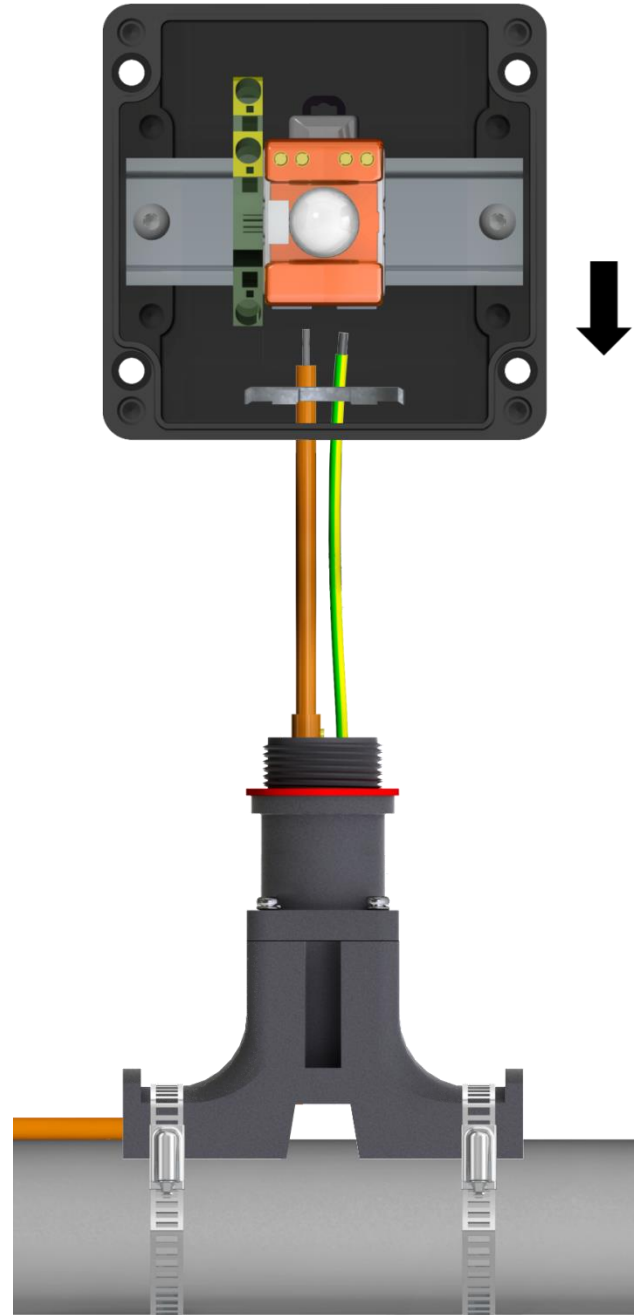

30

## Wiring

- For wire connection at the grounding terminal insert a small screwdriver into the screwdriver slot, then insert the wire.
- For wire connection at the lamp module loosen the fixing screw at the terminal, insert the wire and retighten.
- Connect all wires as shown.
- Check if the tubes of the silicone pants ends up closely to the termination entry.

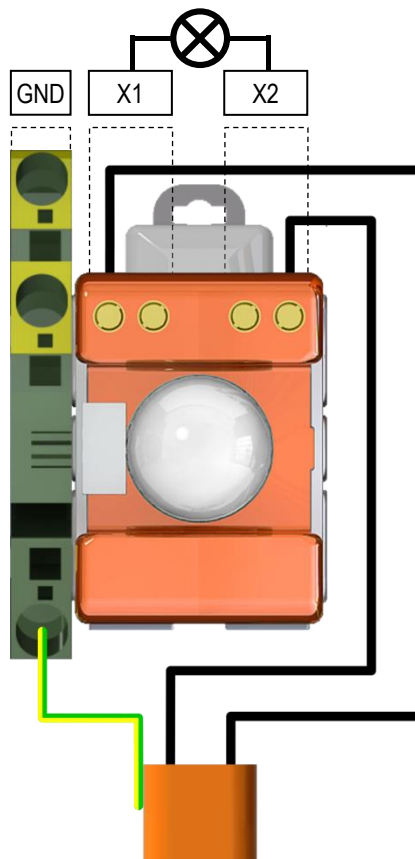
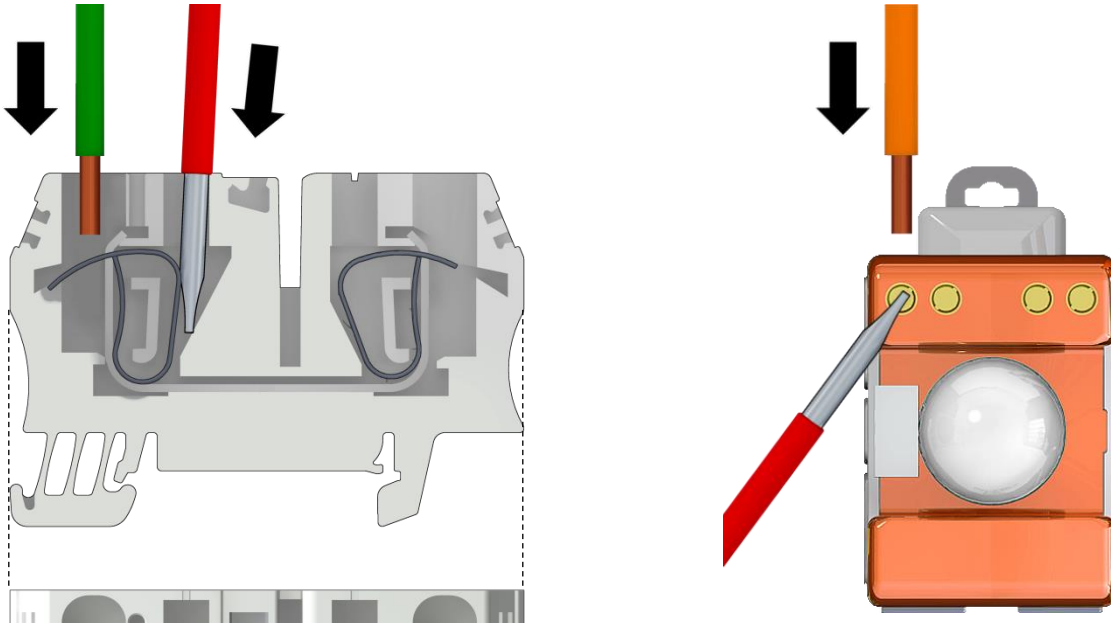

- Mount the cover of the junction box and tighten the 4 fixing screws using a flat screwdriver.

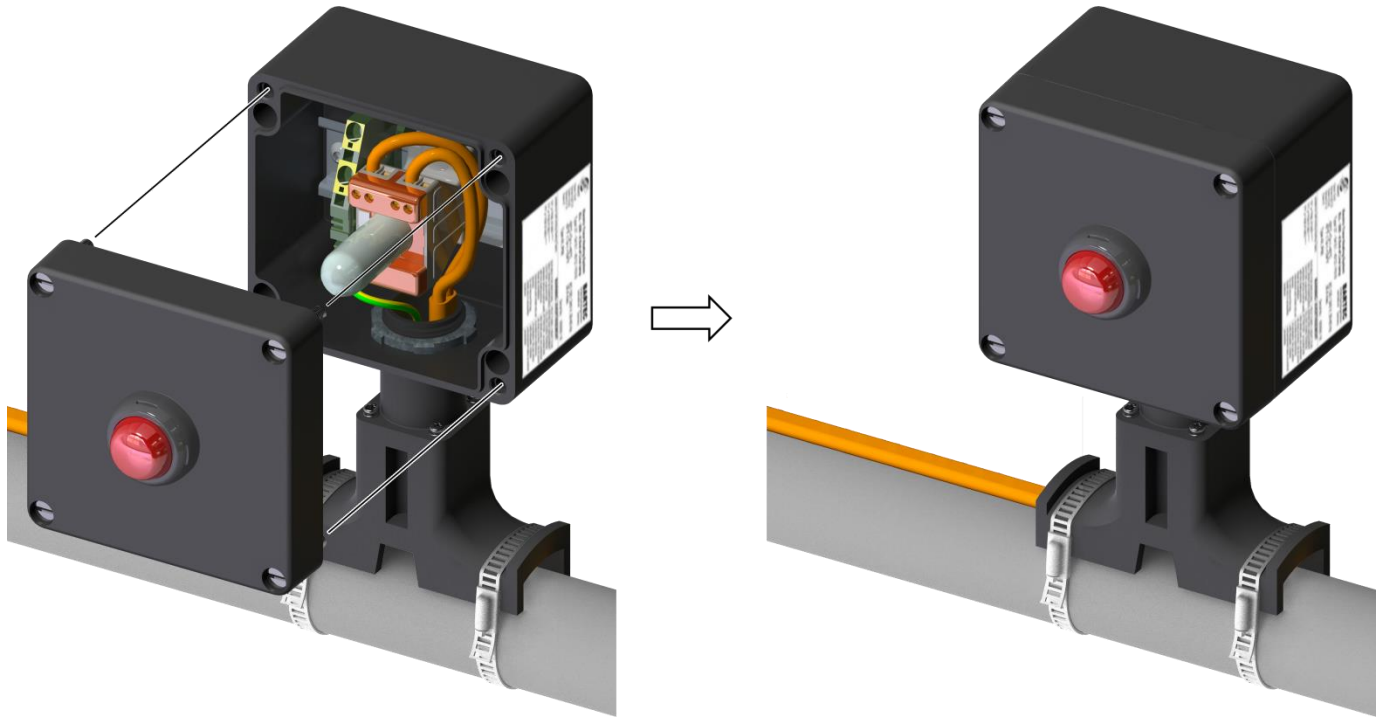

32

- Apply the pipe's insulation according to the manufacturer's installation instructions.
- Apply an electrical warning label every 10 ft. (3 m) on a clearly visible place.

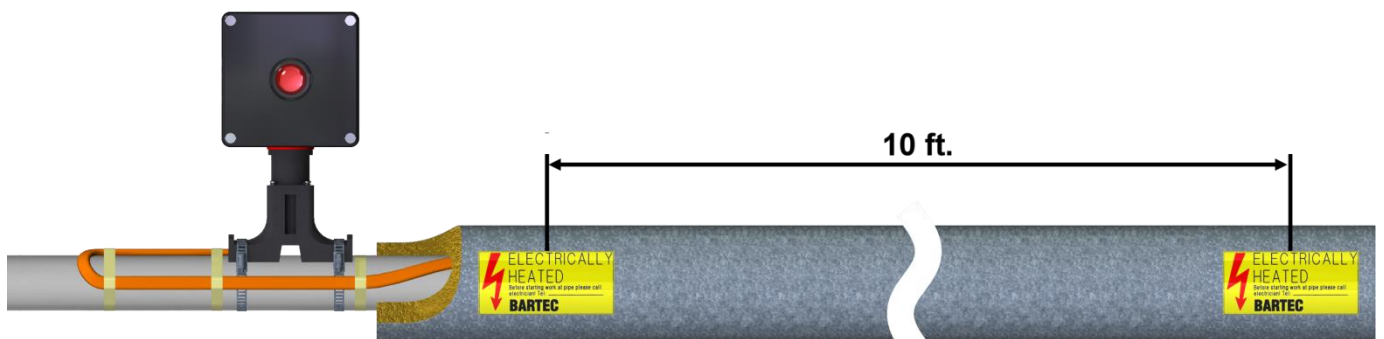

33

## Troubleshooting

Problem	Possible cause	Remedy
Trace heater remains cold	No power supply	Check the power wiring for continuity to circuit breaker.
	Trace heater bus wires or power wiring not properly connected	Connect the trace heater and power wires according to the installation instructions.
	Control unit adjusted incorrectly	Adjust the control unit according to the installation instructions.
Automatic circuit breaker tripped	Automatic circuit breaker defective	Replace the automatic circuit breaker.
	Automatic circuit breaker has wrong tripping characteristics, e. g. "B" instead of "C"	Install an automatic circuit breaker with Type-C tripping characteristics or contact the factory for Type-B tripping characteristics.
	Nominal circuit breaker size is insufficient	Install an automatic circuit breaker with higher capacity. Observe the maximum amperage of all components of the trace heating circuit. Split the heating circuit into separate circuits.
	Maximum heating circuit length has been exceeded	Install the end seal according to the installation instructions.
	End seal has not been installed	Identify the cause and remedy the fault (e. g. ensure that trace heater bus wires are not twisted together). Dry the components. For junction boxes, be sure that the conduit drain is installed and breathing properly.
	Short circuit	
	Humidity inside the connection system or end seal	
Ground fault protection is disengaged	Trace heater damaged	Replace the trace heater at the point where it is damaged.
	Moisture in the components	Dry the components. For junction boxes, be sure that the conduit drain is installed and breathing properly.
	Ground fault protection defective	Replace the ground fault protection device(s).
Low or inconsistent insulation resistance	Trace heater damaged	Replace the trace heater at the point where it is damaged.
	Moisture in the components	Dry the components. For junction boxes, be sure that the conduit drain is installed and breathing properly.
	Arcing due to damaged trace heater insulation	Replace the trace heater at the point where it is damaged.
	Arcing due to inadequate stripping distance between heating element and grounding braid	Check the stripping distance between bus wires/heating element and grounding braid at all power, splice and end seal connections to ensure adequate separation.
		Check for cut or damaged cable or inadequate stripping length.
	Short-circuit between the grounding braid and the heating element or the grounding braid and the pipe	Relocate test leads and retest.
	Test leads touching the junction box	

*Note: High pipe temperature may lower the insulation resistance reading relative to earlier readings on a cold pipe.*

## Limited Product warranty

### Scope

BARTEC warrants that all BARTEC products and accessories that are the subject of this manual will be free from defects in materials and workmanship from and after its date of purchase for a period of 12 (twelve) months.

For the avoidance of doubt, this limited product warranty will **not** cover any damage caused by:

- accidents,
- misuse, improper installation, operation, maintenance or repairs,
- neglect, or
- alteration.

Furthermore, BARTEC cannot be held liable under this warranty for:

- installation or removal costs,
- loss or damage to property,
- indirect, special, incidental or consequential damages (including, without limitation, loss of revenue or anticipated profits), or
- any other damages or costs directly or indirectly related to the warranty issue.

If all warranty conditions are met (as set forth below), BARTEC will, at its sole discretion:

- repair the product,
- replace the product, or
- refund the purchase price paid for the product.

This warranty gives you specific legal rights, and you may also have other rights which vary by country, state or province. Except as specifically provided otherwise in this limited product warranty, the BARTEC Group General Terms and Conditions shall apply.

### General terms and conditions

BARTEC Global Terms and conditions are available at: <https://www.bartec.de/en/terms/>

### Conditions

The limited product warranty is subject to the following conditions:

- proper installation, operation and maintenance in compliance with the state of the technology and the product documentation, and
- presence of completely filled in acceptance reports for all installation, maintenance and repairwork operations.

### How to claim the warranty

To file a claim under the limited product warranty:

- Notify BARTEC or your local BARTEC representative by written correspondence or email within 30 days after identification of a possible warranty issue.
- If requested, you must provide any warranty-related information and documentation to BARTEC, including, without limitation:
  - project planning documents, and
  - acceptance reports for installation, operation, maintenance or repairwork.



**BARTEC GmbH**  
Max-Eyth-Straße 16  
97980 Bad Mergentheim  
Germany

Phone: +49 7931 597-0  
Fax: +49 7931 597-499  
info@bartec.com  
www.bartec.com

**BARTEC US**  
650 Century Plaza Drive, Suite D120  
Houston, Texas  
USA

Phone: +1 281 214-8542  
Fax: +1 281 214-8547  
info@bartec.us  
www.bartec.us