

## Operating Instructions

### **POLARIS SMART HMI**

### **POLARIS SMART HMI 12" W**

Type: 17-71V6-2

**ATEX / IECEX**

**Zone 1 / 21**

Document number: 11-71V1-7D0029

Revision 1, 17. July 2023

Reservation:

Technical data subject to change without notice. Changes, errors, and misprints may not be used as a basis for any claim for damages.



## 0 Table of contents

<b>0</b>	<b>Table of contents</b> .....	<b>3</b>
<b>1</b>	<b>About these operating instructions</b> .....	<b>6</b>
<b>2</b>	<b>Highlighting in the document</b> .....	<b>7</b>
2.1.1	Warnings .....	7
2.1.2	Symbols and icons .....	8
2.2	Handling the product.....	8
2.3	Technical changes.....	8
2.4	Languages.....	8
<b>3</b>	<b>Safety</b> .....	<b>9</b>
3.1	Intended use .....	9
3.1.1	Exclusive purpose .....	9
3.1.2	Improper use.....	9
3.2	Owner's / Managing operator's obligations.....	9
3.3	Qualification of personell .....	10
3.4	Warranty .....	10
3.5	Safety instructions.....	12
3.5.1	General .....	12
3.5.2	Safety instructions for operation.....	12
3.6	Avoidance of damage to property .....	13
3.6.1	Short circuit due to improper connection .....	13
3.6.2	Triggering the safety function.....	13
3.6.3	EMC-compliant connection .....	13
3.6.4	Storage at an excessively high temperature .....	13
3.6.5	Aggressive cleaning agents .....	14
3.6.6	Danger to health due to improper disposal.....	14
3.7	Obligations of the owner.....	14
3.8	Instructions for use .....	14
<b>4</b>	<b>Product description</b> .....	<b>15</b>
4.1	General description.....	15
4.2	Technical data.....	16
4.3	Schematic design.....	17
4.4	Marking and test certificate .....	17
<b>5</b>	<b>Accessories</b> .....	<b>19</b>
5.1	Accessories - Keyboard.....	19
5.1.1	Description.....	19
5.1.2	General data.....	19
5.1.3	Explosion protection .....	19
5.1.4	Accessories – Ex I Memory Stick .....	20
5.1.5	General data.....	20
5.1.6	Explosion protection .....	20

5.2	Accessories – USB Smart Device .....	21
5.2.1	General data.....	21
5.2.2	Explosion protection .....	22
5.2.3	Electric data (USB standard) .....	22
5.2.4	Technical data (Bluetooth) .....	22
5.2.5	Technical data (WLAN) .....	23
5.3	Accessories –Smart Module.....	23
5.3.1	General data.....	23
5.3.2	Explosion protection .....	24
5.3.3	Electrical Data (Smart Module USB to Profibus-DP) .....	25
5.3.4	Electrical Data (Smart Module USB to Serial) .....	25
5.3.5	Electrical Data (Smart Module USB to Ethernet and USB) .....	27
5.3.6	Electrical Data (Smart Module USB to USB Hub) .....	28
<b>6</b>	<b>Transport and storage.....</b>	<b>29</b>
6.1	Scope of delivery.....	29
6.2	Packaging.....	29
6.3	Transport .....	29
6.4	Storage .....	30
6.5	Disposal .....	30
<b>7</b>	<b>Installation and assembly.....</b>	<b>31</b>
7.1	Installation options .....	31
7.2	Assembly preparations.....	32
7.3	Installation.....	32
7.4	Requirements.....	32
7.5	Mechanical installation.....	34
7.5.1	Installation in an enclosure .....	34
7.5.2	Mechanical fitting .....	35
7.6	Electrical installation .....	36
7.6.1	Installation guidelines.....	36
7.7	Rear panel overview .....	37
7.8	PE conductor connection .....	38
7.9	Ex e terminal compartments .....	39
7.9.1	Cable entries.....	39
7.9.2	Terminal Assignment Supply voltage.....	40
7.9.3	Terminal Assignment Ethernet.....	40
7.9.4	Terminal Assignment USB Ex e Interface.....	40
7.9.5	2 x Ex i USB-interface.....	41
7.10	EMC (electromagnetic compability).....	42
7.10.1	Voltage supply (AC- and DC- variants) .....	42
7.10.2	Back-up fuse.....	43
7.10.3	Interference suppression .....	43
7.10.4	Shielding.....	44
7.10.5	Connection of shielding.....	44
7.10.6	Examples of shielding connections .....	44

<b>8</b>	<b>On-Screen-Display .....</b>	<b>46</b>
8.1	Control buttons .....	46
8.2	Unlocking the operating keys .....	46
8.3	Turning on / off.....	47
8.3.1	Turn display on / off.....	47
8.3.2	Turn computer on / off.....	48
8.4	On-screen menu.....	49
8.4.1	Operation of the on-screen menu .....	49
8.4.2	Menu PICTURE .....	50
8.4.3	Menu DISPLAY.....	50
8.4.4	Menu COLOR .....	51
8.4.5	Menu ADVANCE.....	52
8.4.6	Menu INPUT .....	53
8.4.7	Menu OTHER .....	54
8.4.8	Menu INFORMATION .....	55
<b>9</b>	<b>Commisioning .....</b>	<b>56</b>
9.1	Final inspection.....	56
<b>10</b>	<b>Declaration of conformity .....</b>	<b>57</b>
<b>11</b>	<b>Labelling – POLARIS SMART HMI .....</b>	<b>59</b>

## 1 About these operating instructions



Please read carefully before putting the device into operation.  
Please observe the corresponding user manual.

These operating instructions contain the information required for using the **POLARIS SMART HMI** in accordance with its intended purpose. It is addressed to technically qualified personnel. The instructions are a constituent part of the product. It must be always kept in the direct vicinity of the device and accessible to installation, operating and maintenance personnel.

The operating instructions are written for personnel who are qualified to carry out assembly, installation, commissioning, and maintenance work on the product; Where necessary the directives and standards for areas with a gas or dust atmosphere must be observed before start of any work; for example: 2014/34/EU, EN/IEC 60079-17, and EN/IEC 60079-19.

Familiarity with and strict adherence to the safety instructions and warnings in this manual are essential for safe installation and commissioning. Careful handling and consistent observation of these instructions can prevent accidents, injuries, and damage.

The illustrations in these operating instructions serve to make the information and descriptions clearer. The illustrations may deviate from the actual state.

The safety notes and warnings in these operating instructions are given in a general manner.

Should you require further information, please request the required information from your local or responsible BARTEC branch.

Read the operating instructions and in particular the safety instructions carefully before using the device.

- ▶ Keep the operating instructions during the entire service life of the device.

## 2 Highlighting in the document

### 2.1.1 Warnings

Warnings are used in this user manual to warn of property damage and personal injury.

- ▶ Always read and follow these warnings.

Warnings are specially highlighted in this user manual and identified by symbols:

#### **DANGER**

**DANGER** indicates a hazardous situation which, if safety measures are not observed, may result in death or serious injuries with permanent damage.

#### **WARNING**

**WARNING** indicates a hazardous situation which, if safety measures are not observed, may result in serious injuries without permanent damage.

#### **CAUTION**



**CAUTION** indicates a hazardous situation which, if safety measures are not observed, can result in minor injuries.

#### **ATTENTION**

**ATTENTION** indicates a hazardous situation which, if the safety measures are not observed, may result in damage to property.

## 2.1.2 Symbols and icons

Table 1: Symbols and icons

Symbol	Explanation
	Important notices and information for the effective, efficient, and environmentally friendly use of the product.
	Ex application, this symbol indicates special information for Ex applications

## 2.2 Handling the product

The product described in these operating instructions has been tested and left the factory in perfect condition as regards meeting safety requirements. To maintain this condition and ensure that this product operates perfectly and safely, it may be used only in the manner described by the manufacturer. Appropriate transportation, suitable storage and careful operation are also essential for the perfect and safe operation of this product. The **POLARIS SMART HMI** must be installed properly and securely if it is to work perfectly and correctly.

The safe and perfect mounting of the POLARIS is a precondition for faultless and correct operation.

## 2.3 Technical changes

The respective up-to-date versions of data sheets, manuals, certificates, EU Declaration of Conformity may be downloaded at [www.bartec.de](http://www.bartec.de) or ordered directly from BARTEC GmbH.

BARTEC reserves the right to alter the contents of this document without notice. No guarantee is given for the correctness of the information. In case of doubt, the German safety instructions shall apply because it is not possible to rule out errors in translation or in printing. In the event of a legal dispute, the "General Terms and Conditions" of the BARTEC group shall apply in addition.

## 2.4 Languages

The original user manual is written in English. All other available languages are translations of the original user manual.

The user manual is available in German and English. If further languages are required, these must be requested from BARTEC or stated when placing the order.



## 3 Safety

### 3.1 Intended use

#### 3.1.1 Exclusive purpose

It is used exclusively in combination with operating devices which satisfy the requirements for Overvoltage Category I.

The **POLARIS SMART HMI** has been designed specially for use in hazardous (potentially explosive) areas in Zone 1 or Zones 21.

It is essential to observe the permissible operational data for the device being used.

#### 3.1.2 Improper use

Any other use is not in accordance with the intended purpose and can cause damage and accidents. The manufacturer will not be liable for any use beyond that of its Exclusive II intended purpose.

### 3.2 Owner's / Managing operator's obligations

The owner / managing operator undertakes to restrict permission to work with the **POLARIS SMART HMI** to people who:

- are familiar with the basic regulations on safety and accident prevention and have been instructed in the use of the **POLARIS SMART HMI**;
- have read and understood the documentation, the chapter on safety and the warnings.

The owner/managing operator must check that the safety regulations and accident prevention rules valid for the respective application are being observed.

### 3.3 Qualification of personell

Table 2: Tasks of individual target groups

Target group	Skills
Design / engineering	<ul style="list-style-type: none"> <li>• Technical training</li> <li>• Knowledge and experience to identify and avoid hazards that may be caused by electricity</li> <li>• Understanding of the overall system</li> <li>• Configuration / programming</li> <li>• Special introduction for the Ex-area</li> </ul>
Electrician / installer	<ul style="list-style-type: none"> <li>• Technical training</li> <li>• Knowledge and experience to identify and avoid hazards that may be caused by electricity</li> <li>• Understanding of the overall system</li> <li>• Special introduction for the Ex-area</li> </ul>
Operator	<ul style="list-style-type: none"> <li>• Induction in operation by the owner</li> <li>• Special introduction for the Ex-area</li> </ul>
Storage and transport companies	<ul style="list-style-type: none"> <li>• Loading and transport activities</li> <li>• Professional storage</li> </ul>

### 3.4 Warranty

#### WARNING

UNAUTHORISED MODIFICATIONS AND/OR ALTERATIONS TO THE POLARIS SMART HMI.

- ▶ Explosion protection as well as design and manufacture in line with strain and safety requirements are no longer guaranteed.
- ▶ Do not take any modifications or conversions on device.
- ▶ Before making any modifications or alterations, contact the manufacturer to obtain written approval.
- ▶ Use only original spare parts and original wearing parts.

Assumption of warranty



The manufacturer assumes the complete warranty only and exclusively for the spare parts ordered from the manufacturer.

As a basic rule, our “General Terms, Conditions of Sale, and Delivery” apply. They are available to the managing operator on conclusion of contract at the latest. Warranty and liability claims for personal injury and damage to property are excluded if they are due to one or several of the following reasons:

- Improper use of the **POLARIS SMART HMI**.
- Incorrect installation, commissioning, operation, and maintenance of the **POLARIS SMART HMI**.
- Non-compliance with the instructions in the manual with respect to transport, storage, assembly, commissioning, operation, and maintenance.
- Unauthorized structural changes to the **POLARIS SMART HMI**.
- Inadequate monitoring of parts that are subject to wear.
- Improperly performed repairs.
- Disasters caused by foreign bodies and force majeure.

We guarantee the **POLARIS SMART HMI** and its accessories for a period of one year starting on the date of delivery from the Bad Mergentheim plant. This warranty covers all parts of the delivery and is restricted to the replacement free of charge or the repair of the defective parts in our plant in Bad Mergentheim / Germany. Any packaging delivered should be kept where possible. In the event of a claim, the product must be returned to Bartec after written arrangement. There is no entitlement to rectification at the site of installation.

## 3.5 Safety instructions

### 3.5.1 General

- Do not dry wipe or clean devices in hazardous areas!
- Do not open devices in hazardous areas.
- The general statutory regulations or guidelines relating to safety at work, accident prevention and environmental protection legislation must be observed, e.g. the German Industrial Health and Safety Ordinance (BetrSichV) or the applicable national ordinances.
- In view of the risk of dangerous electrostatic charging, wear appropriate clothing and footwear.
- Avoid exposure to heat outside the specified temperature range (see Chapter "General technical data").
- Protect the device from external influences! Do not expose the device to any caustic/aggressive liquids, vapours or mist! In the event of malfunctioning or damage to the enclosure, take the device out of the potentially explosive area immediately and bring it to a safe place.

### 3.5.2 Safety instructions for operation

#### Commissioning

- Before commissioning, check that all components and documents are available.

#### Inspection

- Under EN/IEC 60079-17 and EN/IEC 60079-19, the owner of electrical systems in hazardous areas is obliged to have them checked by a qualified electrician to ensure that they are in a proper condition.

#### Maintenance

- For electrical systems, the relevant installation and operating regulations must be observed (e.g. Directive 99/92/EC, Directive 2014/34/EUEC, BetrSichV or the nationally applicable ordinances EN/IEC 60079-14).
- Please observe the national waste disposal regulations for disposal.

### Servicing

- Regular servicing is not necessary if the device is operated correctly in accordance with the installation instructions and ambient conditions.
- BARTEC recommends annual servicing and inspection.
- See Chapter "Maintenance and care".

### Repairs

- Only authorized persons working in accordance with the latest development in technology and using original spare parts may do repairs on explosion-protected equipment. The applicable provisions must be observed.
- Repairs must be carried out in accordance with EN / IEC 60079-19.
- Only original spare parts are to be used. Order the spare parts from your local representative.

## 3.6 Avoidance of damage to property

### 3.6.1 Short circuit due to improper connection

An incorrect connection of the power supply will destroy the electronics and void the warranty.

### 3.6.2 Triggering the safety function

Switching on again too quickly after switching off can cause internal voltage peaks in the power supply unit and thus trigger a safety function. After switching off the voltage path, wait at least 30 seconds before switching on again.

### 3.6.3 EMC-compliant connection

For the safe function of the **POLARIS SMART HMI** it is important to carry out the wiring in accordance with EMC. This includes observing the chapter "EMC-compliant connection".

### 3.6.4 Storage at an excessively high temperature

Store the **POLARIS SMART HMI** at the intended storage temperature since otherwise damage to the electronics or seals may occur. Ensure adequate air conditioning at high storage temperatures.

### 3.6.5 Aggressive cleaning agents

When selecting the correct cleaning agent, it is essential that it is suitable for use since otherwise damage may occur to seals and connections. Combustible products are generally not permitted.

### 3.6.6 Danger to health due to improper disposal

According to the European WEEE Directive, electrical and electronic equipment may not be disposed of with household waste. Their components must be sent separately for recycling or disposal because toxic and hazardous components can cause long-term damage to health and the environment if not disposed of properly.

As consumers, you are obliged under the Electrical and Electronic Equipment Act (ElektroG) to return electrical and electronic equipment at the end of its serviceable life free of charge to the manufacturer, the point of sale or to public collection points set up for this purpose. Details of this are regulated by the respective national law. The symbol on the product, the operating instructions or/and the packaging refers to these regulations. With this type of material separation, recycling, and disposal of old devices, you make an important contribution to the protection of our environment.

## 3.7 Obligations of the owner

The owner undertakes to restrict permission to work with and on the **POLARIS SMART HMI with 12"** to people who:

- ➔ are familiar with the basic regulations on safety and accident prevention and have been instructed in the use of the **POLARIS SMART HMI**;
- ➔ have read and understood the documentation, the chapter on safety and the warnings.
- ➔ The owner must check that the safety regulations and accident prevention rules valid for the respective application are observed.

## 3.8 Instructions for use

- ➔ The overvoltage category II of the non-intrinsically safe circuits according to IEC 60664-1 must be observed.
- ➔ The warning "WARNING – DO NOT OPEN UNDER VOLTAGE" must be part of the external marking of the entire electrical device or the enclosure must have a locking system to prevent the fuses from being energized during replacement.

## 4 Product description

### 4.1 General description

The **POLARIS SMART HMI** is an innovative further development of the POLARIS series.

High-resolution display with LED technology and bonded capacitive touchscreen for an intuitive and comfortable operation.

State-of-the-art LED display technology ensures an optimum contrast event with a large viewing angle.

*Illustration 1: POLARIS SMART HMI*



The **POLARIS SMART HMI** has been equipped as standard with the the Intel® Atom™ Prozessor with 4 cores. The open Windows operating system makes the device series in the market unique. Working with the BMS-Graf-Pro is also possible.



A direct connection to the control or to the process control system is possible through Ethernet.

The intrinsically safe USB interfaces can be reached directly on the back.

Wired electrical connections are made via integrated terminal compartments.

The use of the BARTEC Ex i memory stick through the intrinsically safe USB interface allows data to be transferred easily, stored, and saved for system restoration by means of the backup function.

The front-panel mounting design makes installation easy. On request, the devices are also available as a ready-made system solution in a stainless-steel enclosure for wall, floor or table mounting.

For particularly harsh areas of use with temperatures as low as down to -40 °C, we equip the POLARIS series with electrical heating. On request, we produce customised solutions with more command and signalling devices.

## 4.2 Technical data

POLARIS SMART HMI TECHNICAL DATA	
Construction	Front panel fitting
Computer capacity	CPU Intel® Atom™ Quad Core CPU, RAM: up to 16GB DDR4, 64 GB internal flash drive, Optional: Hard-drive SSD with 240 GB (MLC) Power protected or higher. Windows® 10 IoT Enterprise 64 Bit LTSC
Operating system	Open platform for customer-specific visualization software, e. g. ProTool, WIN CC flexible, etc. for BMS-Graf-pro Version 7
Display	12.1" W TFT-Display, 16,7M colors, XGA-Resolution 1280 x 800 pixels, Brightness 600 cd/m <sup>2</sup> Visible surface approx. 261,1 x 163,2 mm Contrast 1000:1, Antireflection coating glass pane
Touch	Capacitive touch, non-reflecting through Bonding
Power supply	DC 24V ±10 %
Max. power consumption	Pmax. (with USB) < 37 W Pmax. (without USB) < 32 W Normal use without USB approx. 22 W
Permissible ambient humidity	5 to 95 % (non-condensing)
Vibration	0.7 G/1 mm; 5 Hz-500 Hz pulse in all 3 axes
Schock	15 G, 11 ms pulse in all 3 axes
Material	Capacitive touch: hardened glass front / Aluminium Frame Stainless steel
• Front / display	
• Rear site	
Protection class	IP65 according to EN/IEC 60079-0 IP65 according to EN/IEC 60079-0
• Front / display	
• Rear site	
Optional ex approved accessories	Keyboard Ex i memory stick Smart USB Device WLAN Smart USB Device Bluetooth Smart Module USB to Ethernet and USB Smart Module USB to Profibus-DP Smart Module USB to USB Hub Smart Module USB to Serial (RS232, RS422/485, TTY)
Interface (Basic version)	1 x Ex e Ethernet 10/100 BaseT 2 x Ex e USB 2,0 2 x Ex i USB 2,0
Permissible temperature	-20 °C to +60 °C
• Storage	
• Operation	0 °C to +50 °C
• Optional	Operation -20 °C to +60 °C see installation options 7.1
Backlighting	LED technology, Service life approx. 50,000 hours (at +25 °C)
Dimensions (width x height x depth)	407 mm x 271 mm x 110 mm
Wall cutout (width x height)	386 mm x 251 mm
Weight	Approx. 12,3 kg



### 4.3 Schematic design

Illustration 2: example System configuration

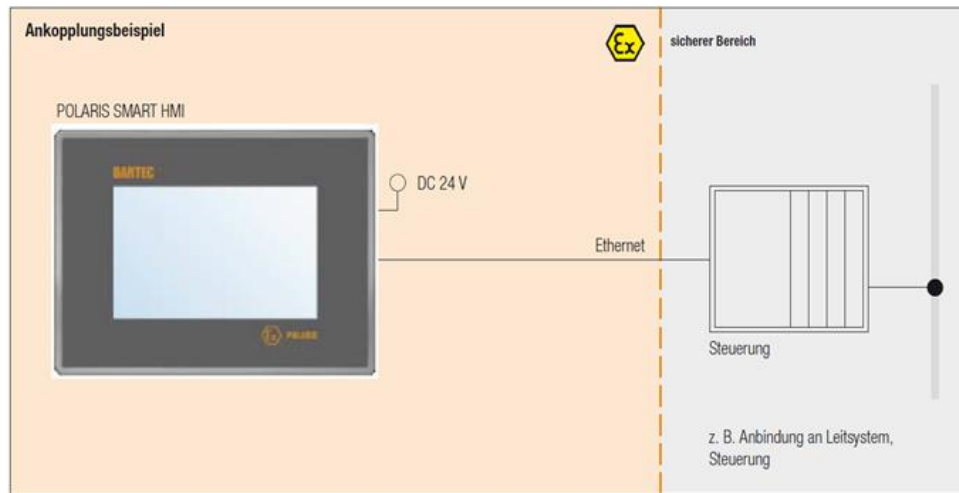

### 4.4 Marking and test certificate

The **POLARIS SMART HMI** is approved for the following areas.

ATEX	
Ex protection type	Ex II 2G Ex eb q [ib] IIC Gb
Marking	Ex II 2D Ex tb IIIC T120° Db -20 °C Ta 60 °C
Certificaten	IBExU 05 ATEX 1117 X
IECEX	
Marking	Ex eb q [ib] IIC T4 Ex tb IIIC T120 °C
certificaten	IECEX IBE 11.0007X
 Special conditions	The intrinsically safe circuits and the enclosure are galvanically connected. The equipotential bonding must be guaranteed at the installation of the intrinsically safe circuits. High charging mechanisms at the operation surface of the Visual units respectively accessories (for example pneumatic particle transport) must be excluded at the application. The supporting frame has to be used when the visual unit is mounted in separate enclosure.

Further test certificates

More test certificates [www.bartec.de](http://www.bartec.de)

EU – conformity

Product conforms with	RoHS Directive 2011/65/EU REACH Directive 1907/2006/EU EMC Directive 2014/34/EU
Electrical safety	EN/IEC 61010-1:2010
Product labelling	 0044 UKEX Symbol 2503

## 5 Accessories

### 5.1 Accessories - Keyboard

#### 5.1.1 Description

The intrinsically keyboard of the **POLARIS SMART HMI** is intended for zone 1 and 2, as well as for zone 21 and 22.

The keyboard is connected to the intrinsically USB socket, besides, it can be connected to the complete POLARIS series.

The complete stainless-steel keyboard can be also used in industrial extreme terms (nearly insensitive against effect of violence) and offers with the long hub keys a high ease of use. The keyboard is available in different languages.

#### 5.1.2 General data

Illustration 3: Keyboard sample picture



#### Keyboard Type: 17-71VZ-C01\*/0000

Construction	Front panel fitting
Material	Stainless steel
Protection class (front)	IP65
Dimensions (width x height)	250 mm x 135 mm
Wall cut-out (width x height)	235 mm x 110 mm
Installation depth	32 mm
Interface	PS/2, USB
Other features	Keyboard available in various languages, with 62 buttons

#### 5.1.3 Explosion protection

#### Keyboard type: 17-71VZ-C01\*/0000

#### ATEX (Europe)

Marking	⊕ II 2G Ex ib IIC T4 Gb
	⊕ II 2D Ex ib IIIC T120°C Db -20 °C Ta 60 °C
Test certificate	IBExU 05 ATEX 1117 X

#### IECEx (International)

Marking	Ex eb q [ib] IIC T4
	Ex tb IIIC T120 °C
Test certificate	IECEx IBE 11.0007X

#### Further test certificates

More test certificates	<a href="http://www.bartec.de">www.bartec.de</a>
------------------------	--

## 5.1.4 Accessories – Ex I Memory Stick

## 5.1.5 General data



USB-Stick admitted for Agile X IS and POLARIS SMART HMI

Illustration 4: Ex I Memory Stick sample pictures



Ex I Memory Stick type:	USB flash drive
Storage capacity	8 GB/16 GB
Use	Data backup and Ex i recovery stick
Material	Plastic / Sheet Steel
Dimensions (width x height)	approx 34 mm x 11 mm x 4 mm
Weight	<15 g

## 5.1.6 Explosion protection

Ex I Memory Stick type: 17-71VZ-5100/02**	
ATEX (Europe)	
Marking	⊕ II 2G Ex ib IIC T4 Gb -20 °C Ta 60 °C
Test certificate	IBEXU 05 ATEX 1117 X
IECEx (International)	
Marking	Ex ib IIC T4
Test certificate	IECEx IBE 11.0007 X
Further test certificates	
More test certificates	<a href="http://www.bartec.de">www.bartec.de</a>
Ex I Memory Stick type: 17-A1Z0-0007	
ATEX (Europe)	
Marking	⊕ II 2G Ex ib IIC T4 Gb -20 °C Ta 60 °C
Test certificate	DEMKO 16 ATEX 1803 Rev. 0
IECEx (International)	
Marking	Ex ib IIC T4
Test certificate	IECEx UL 16.0160
Further test certificates	
More test certificates	<a href="http://www.bartec.de">www.bartec.de</a>

## 5.2 Accessories – USB Smart Device

### 5.2.1 General data

#### USB Smart Device type:

Fastening	M30 x 1,5 (suitable for fixing holes 30,3mm)
Installation	Wall thickness 1mm to 6mm impact resistance: 7Nm
Torque of panel nut	2,8 to 3,4 Nm
Material	Enclosure thermoplastic

#### USB Smart Device type:

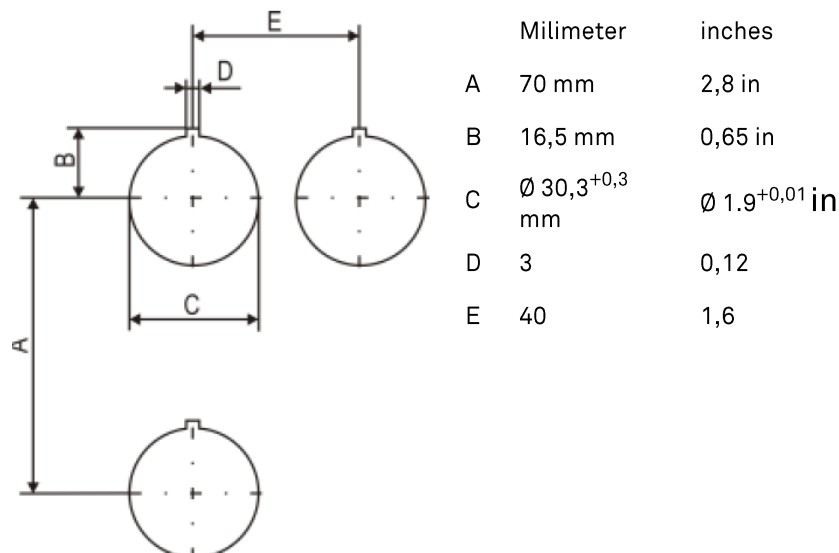

Fixing hole of the size  $\varnothing 30,3$  mm (1.9 in) with recess for anti-twist safeguard, typical position on top (12 o'clock position).

Minimum distances of the fixing holes:

- horizontal 40 mm (1.6in)
- vertical 70 mm (2.8 in)

Recommended distance for mushroom push button, shock switch as well as selector switch with protective collar: 100 mm (3.9 in).

### 5.2.2 Explosion protection

USB Smart Device type type: 17-71VZ-A0x0/0000	
ATEX (Europe)	
Marking	II 2G Ex eb mb IIC T4 Gb II 2D Ex tb IIIC T120 °C Db -20 °C Ta 60 °C
Test certificate	IBExU 05 ATEX 1117 X
IECEX (International)	
Marking	Ex eb mb IIC T4 Ex tb IIIC T120 °C
Test certificate	IECEX IBE 11.0007X
Protection class	
Protection class	IP66 (Threaded base)
Further test certificates	
More test certificates	<a href="http://www.bartec.de">www.bartec.de</a>



Suitable for installation in 2G-, 2D-, 3G- or 3D enclosure. Connection via USB Ex-e.

### 5.2.3 Electric data (USB standard)

USB Standard			
USB – connection	Colour	Function	
1	RD	V+	
2	WH	Data-	USB-data signal
3	GN	Data+	USB-data signal
4	BK	V-	

### 5.2.4 Technical data (Bluetooth)

Illustration 5: bluetooth sample pictures



Bluetooth 4.0 type:	
Downward compatible	2.0 / 2.1 / 3.0
Range	Up to 10m (free terrain)
For more technical data see description of the bluetooth-stick manufacturer.	

### 5.2.5 Technical data (WLAN)

Illustration 6: WLAN sample pictures

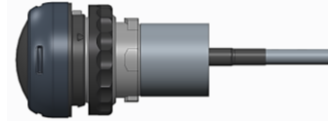

#### WLAN type:

	IEEE802.11n
Wifi - standard	IEEE802.11g IEEE802.11b
Transfer rate	max. 150 Mbit/s
WLAN - frequency	2.4 GHz

For more technical data see description of the WLAN-stick manufacturer.

## 5.3 Accessories –Smart Module

### 5.3.1 General data

There are currently 4 different Polaris Smart Modul Types which are used to expand the Polaris series interfaces. The smart modules are connected to the USB Ex-e interfaces of the Polaris Series. The modules are in approved ComEx housing installed.

The Smart Modules are designed for use in hazardous areas suitable in zones 1/21.

Illustration 7: Smart Module sample picture



#### Smart Module

Material	PP-GF40-0405
Protection class (front)	IP66 / IP67
Dimensions (width x height x depth)	178 mm x 188mm x 81mm
Interface	see electrical Data each module

## 5.3.2 Explosion protection

Smart Module USB to Profibus-DP: 17-71VZ-B010	
ATEX (Europe)	
Marking	II 2G Ex eb mb IIC Gb II 2D Ex tb IIIC T120°C Db -20 °C Ta 55 °C
Test certificate	IBExU 05 ATEX 1117 X
IECEX (International)	
Marking	Ex eb mb IIC Gb Ex tb IIIC T120 °C Db
Test certificate	IECEX IBE 11.0007X
Further test certificates	
More test certificates	<a href="http://www.bartec.de">www.bartec.de</a>
Ex Type label	



Suitable for installation in 2G-, 2D-, 3G- or 3D enclosure. Connection via USB Ex-e.



### 5.3.3 Electrical Data (Smart Module USB to Profibus-DP)

Illustration 8: Smart Module USB to Profibus-DP picture

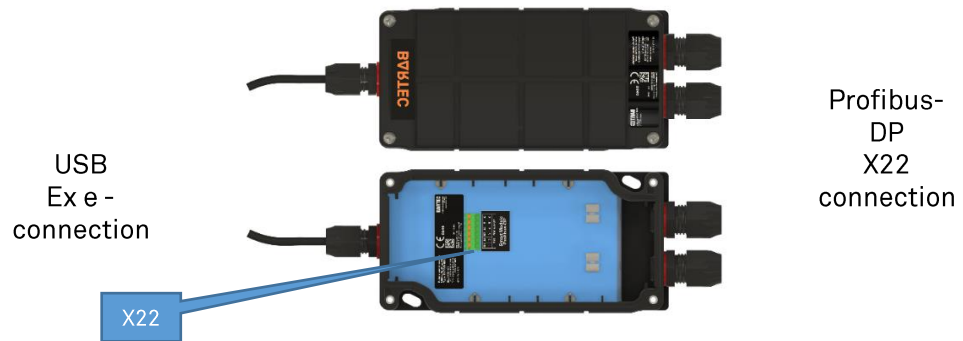

Smart Module USB to Profibus-DP: 17-71VZ-B010		
USB Ex e – connection	Colour	Function
1	RD	V+
2	WH	Data- USB-data signal
3	GN	Data+ USB-data signal
4	BK	V-

  

Profibus-DP connection	Pin	Function
	1	B1
	2	A1
	3	B2
	4	A2
	5	B
	6	A

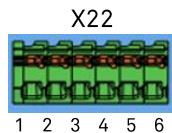

### 5.3.4 Electrical Data (Smart Module USB to Serial)

Illustration 9: Smart Module USB to Serial picture

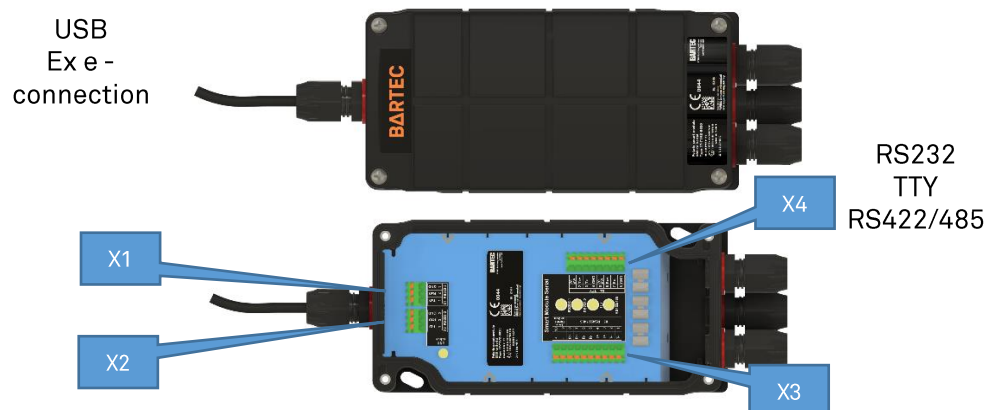

Smart Module USB to Serial: 17-71VZ-B020		
USB Ex e- connection	Colour	Function
1	RD	V+
2	WH	Data- USB-data signal
3	GN	Data+ USB-data signal
4	BK	V-

  

RS232 connection	Pin	Function
<p>X2 / X1</p>  <p>1 2 3 1 2 3</p>	1	TXD
	2	RXD
	3	GND

RS422/485 connection	Pin	Function
<p>X3</p>  <p>1 2 3 4 5 6 7 8 9 10</p>	1	T-
	2	T-
	3	T+
	4	T+
	5	R-
	6	R-
	7	R+
	8	R+
	9	-
	10	+

  

TTY connection	Pin	Function
<p>X4</p>  <p>1 2 3 4 5 6 7 8</p>	1	20mA
	2	Tx+
	3	Tx-
	4	GND
	5	20mA
	6	Rx+
	7	Rx-
	8	GND

### 5.3.5 Electrical Data (Smart Module USB to Ethernet and USB)

Illustration 10: Smart Module USB to Ethernet and USB picture

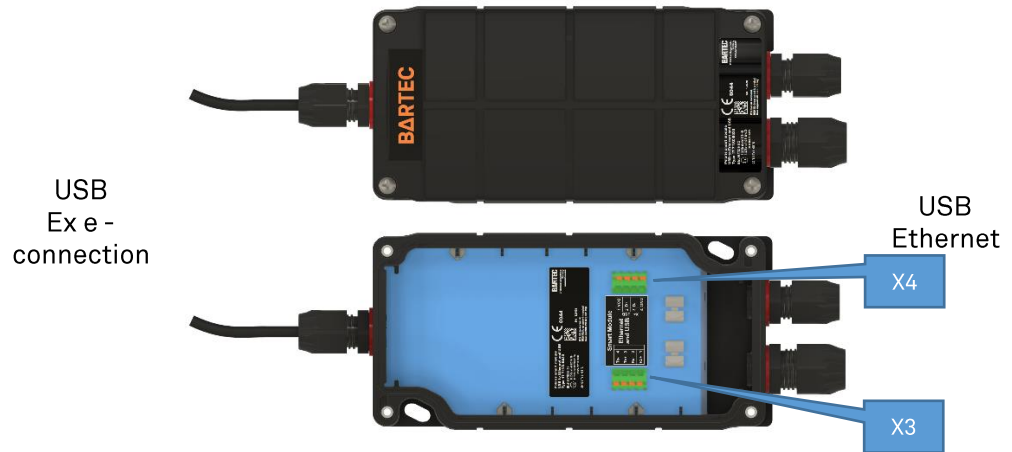

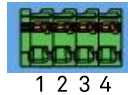
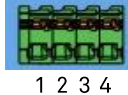
Smart Module USB to Ethernet and USB: 17-71VZ-B030		
USB Ex e-connection	Colour	Function
1	RD	V+
2	WH	Data- USB-data signal
3	GN	Data+ USB-data signal
4	BK	V-
Ethernet connection		
 X3 1 2 3 4	Pin	Function
	1	RxD+
	2	RxD-
	3	TxD+
	4	TxD-
USB 1 connection		
 X4 1 2 3 4	Pin	Function
	1	VCC
	2	D-
	3	D+
	4	GND

### 5.3.6 Electrical Data (Smart Module USB to USB Hub)

Illustration 11: Smart Module USB to USB Hub picture



#### Smart Module USB to USB Hub: 17-71VZ-B040

USB Ex e- connection	Colour	Function
1	RD	V+
2	WH	Data- USB-data signal
3	GN	Data+ USB-data signal
4	BK	V-

Supply Voltage	Colour	Function
	RD	+24V DV
	BK	GND

USB Ex e- connection	Pin	Function
 X1 / X2 / X3 1 2 3 4	1	V+
	2	Data- USB-data signal
	3	Data+ USB-data signal
	4	V-

## 6 Transport and storage

### 6.1 Scope of delivery



Missing parts or damage must be reported immediately on receipt of the delivery in writing to the forwarding agent, the insurance company or BARTEC GmbH.

Damage caused by incorrect storage and transport shall not fall within the warranty provisions of BARTEC GmbH.

Check the completeness of the scope of delivery using the delivery note.

As standard, each **POLARIS SMART HMI** is delivered with the following scope of delivery

- 1x **POLARIS SMART HMI**
- 1x Reinforcement fram
- 1x Set of mounting clamps
- 1x Operating instructions

**Not enclosed:**

- Assembly material
- Cable for voltage supply and data line

**Accessories - optional:**

- Keyboard, Smart Device, USB-stick, Polaris Smart Module,
- Enclosure and supporting system for wall, floor and table mounting

### 6.2 Packaging

The **POLARIS SMART HMI** is delivered in boxes.

- Dispose of the packaging materials at the designated disposal points. Observe the applicable national regulations for disposal.

### 6.3 Transport

#### ATTENTION

**AVOID HARD IMPACTS, E.G. BY FALLING DOWN OR SETTING DOWN TOO VIGOROUSLY.**

The **POLARIS SMART HMI** may be damaged.

Observe the weight of the goods to be transported and select an adequate transport device.

## 6.4 Storage

### ATTENTION

#### Damage to property through incorrect storage!

- ▶ Comply with the correct storage temperatures.
- ▶ Keep the **POLARIS SMART HMI** free of moisture.

Store the **POLARIS SMART HMI** in a horizontal position and at a temperature of -20 °C to +60 °C in its original packaging. The environment must be dry, dust-free, and low vibration.

Store the **POLARIS SMART HMI** for a maximum of 2 years.

For warehouse logistics, we recommend the “first in – first out” principle.

## 6.5 Disposal

The **POLARIS SMART HMI** contains metal, plastic and electronic components.



Our devices are intended as professional electrical devices for exclusively commercial use, so-called B2B devices according to the WEEE Directive. The WEEE Directive provides the framework for the EU-wide treatment of waste electrical equipment. This means that you are not allowed to dispose of these devices with the normal household waste, but must dispose of them in a separate collection in an environmentally friendly manner and cannot hand them in at the collection points of the public waste disposal authorities.

All products purchased from us can be returned to us by our customers in the event of disposal. We ensure disposal in accordance with the applicable statutory regulations. The costs for shipping/packaging are borne by the sender. Observe the applicable national disposal regulations.

## 7 Installation and assembly

### 7.1 Installation options

The POLARIS SMART HMI can be installed directly in:

- Enclosures
- Switch cabinet doors
- Operating consoles

The POLARIS series are mounted by fitting them into front panels. On request, we supply the operating devices as ready-to-use system solutions in stainless steel enclosures for mounting onto walls, floors or tables.

For proper mounting of the POLARIS, the wall cutout should be 386 mm x 251 mm (width x height) to fit properly.

*Illustration 12: Examples of floor and wallmounting in an enclosure*

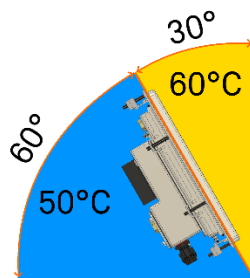
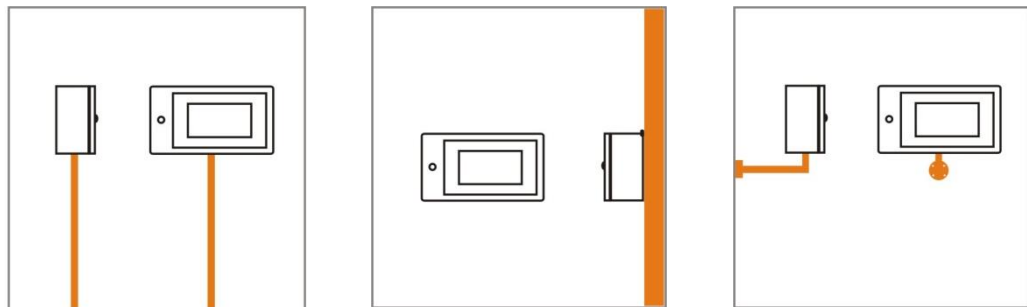

#### ATTENTION

**For Polaris SMART HMI wit extended temperature range -20 to +60°C**

- ▶ During installation, it should be noted that the tilt angle of the Polaris SMART HMI must be at least 60°.

## 7.2 Assembly preparations

Before assembling the [Keywords], make sure all the components and documents are available.

Required tools	
POLARIS SMART HMI - mounting clamps	1 x hexagon socket 3mm
POLARIS SMART HMI – terminal compartments	1 x socket wrenches 7 mm 1 x slotted screwdriver
POLARIS SMART HMI - PE-connection	1 x socket wrenches 7mm

## 7.3 Installation



We recommend setting up and testing the entire Polaris Smart HMI System before its ultimate installation in the ex-area. If a long connection cable is not available, please use a patch cable to test the basic functions



The Polaris Smart HMI is approved for an ambient temperature from 0 °C to +50 °C or from -20 °C to +60 °C and a relative air humidity of from 5 to 95 % without condensation.

### DANGER

#### **Electrostatic charging through a stream of particles.**

There is a risk of fatal injury in an explosive atmosphere!

- ▶ Make sure there are no highly energetic charging mechanisms at the user interface on the display unit or its accessories.
- ▶ Do not install the device in the stream of particles.

### DANGER

#### **No PE connection. Risk of fatal injury in an explosive atmosphere!**

- ▶ The POLARIS must be integrated in the equipotential bonding.

## 7.4 Requirements

Following requirements are valid for **POLARIS SMART HMI**

- The place where the **POLARIS SMART HMI** is installed must have sufficient mechanical stability / fastening.
- The enclosure intended for accommodating the **POLARIS SMART HMI** or [Keywords] must be designed to bear the device's weight.
- If a supporting system is used, the surface underneath and the means of fastening the supporting system must be designed to bear the weight of the the **POLARIS SMART HMI**[Keywords].



## Selecting the location

### CAUTION

**Pay attention to wall and ground condition!**

**A sufficiently stable wall (e.g. concrete or limestone) or floor (e.g. concrete) must be selected for securing the load-bearing system.**

- ▶ The structural stability of the wall or floor must be able to bear 4 times the weight of the **POLARIS SMART HMI**
  - ▶ The support arm system must be assembled using suitable mounting materials
- 
- Choose the optimum height for operating the **POLARIS SMART HMI**[Keywords].
  - Ensure good lighting conditions for a perfectly legible display (no direct exposure to the sun's rays)
  - Do not mount in direct proximity to switching or current changing devices.
  - Only install the **POLARIS SMART HMI** or [Keywords] in conjunction with the reinforcement frame in an IP65 enclosure. Failure to comply with this can lead to water penetrating and damaging the device.

## Outdoor installation

### ATTENTION

**Damage from condensation or overheating!**

- ▶ Avoid direct sunlight!  
Remedy: e.g. shelter with sufficient air circulation.
- ▶ Remove condensation on the **POLARIS SMART HMI**
- ▶ Equip the protective housing with breather.

## 7.5 Mechanical installation

### **⚠ CAUTION**

**This device is heavy (approx. 12,3 kg).**

- ▶ Risk of injury if it is lifted or moved incorrectly.



Only qualified personnel, i.e. trained skilled specialists will have the necessary specialised know-how to be able to perform all the mechanical work. Familiarity with and the technically perfect implementation of the safety instructions described in this manual are preconditions for safe installation and commissioning.

*Illustration 13: Polaris SMART HMI 12" W*

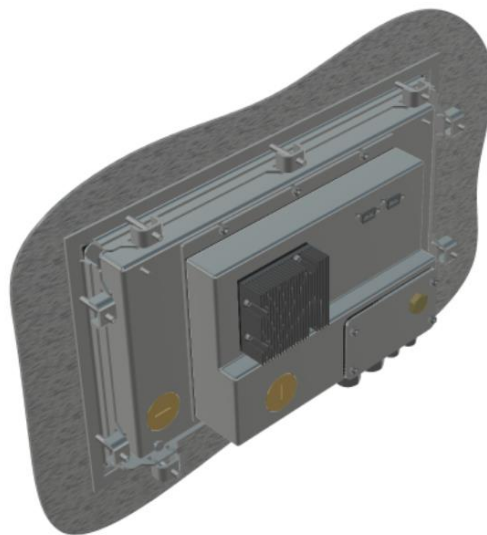

### 7.5.1 Installation in an enclosure

A reinforcement frame is inserted between the retaining brackets and the enclosure material for good transmission of the clamping force. This ensures even transmission of force.



**when built into the enclosure door:**

The open door must be supported and secured during the installation and servicing phase. Otherwise the wall thickness specified may lead to the door sagging slightly when open.

### 7.5.2 Mechanical fitting

#### Work steps

- 1) Insert the **POLARIS SMART HMI** System with CPU unit into the cut-out in the enclosure.
- 2) From the back, place the reinforcement frame over the POLARIS.

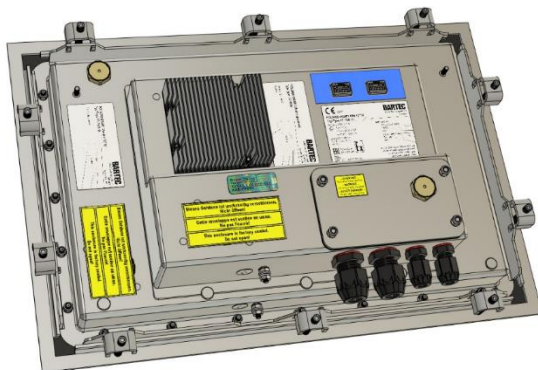

- 3) Slide the retaining claws (10 pieces) into the recesses provided for them on the **POLARIS SMART HMI**.

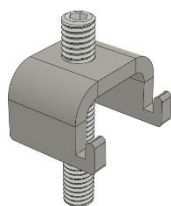

- 4) Tighten the screws of the retaining claws with a torque of max. 1.0 Nm and make sure that the screw tips engage in the recesses of the stiffening frame.

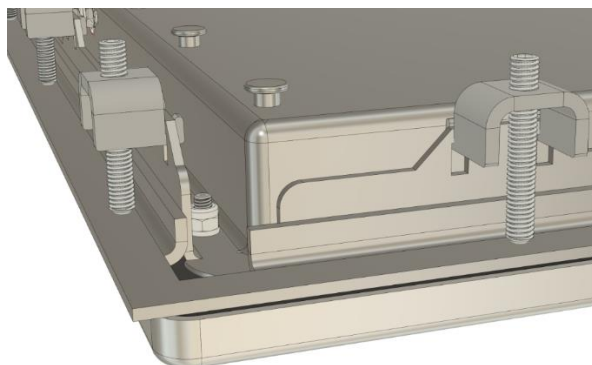

Always tighten the mounting clamps crosswise.

## 7.6 Electrical installation

### 7.6.1 Installation guidelines



Only qualified personnel, i.e. trained electricians will have the required specialised knowledge to be able to do all the electrical work.

Familiarity with and the technically perfect implementation of the safety instructions described in this manual are preconditions for safe installation and commissioning.

- The user may do only the wiring at the terminals that are accessible to him/her (Ex i and Ex e terminal compartment).
- Any unused cable glands on the Ex e terminal compartment should be closed using an approved blanking plug.
- More extensive dismantling work on the device may be done only by the manufacturer or by persons authorised by the manufacturer for this purpose. The device is factory-sealed. Never open it!
- The equipotential bonding connection point must be connected to the equipotential bonding conductor in the hazardous area. Since the intrinsically safe circuits are galvanically connected to earth, equipotential bonding is required throughout the entire installation of the intrinsically safe circuits.
- The safety and accident prevention regulations applicable to the respective individual case must be observed.
- Devices must be properly installed first before they may be operated.
- It must be always possible to disconnect the devices from the voltage supply (in fixed installations by means of an all-pole main isolating switch or fuse).
- It must be ensured that the supply voltage agrees with the specifications in this user manual and the tolerances must be observed. Use smoothed direct current.
- Malfunctioning cannot be ruled out if levels exceed or drop below the specified tolerances.
- If there is a power failure or if the power supply is interrupted, make sure the system has not been put into a dangerous, undefined condition.
- EMERGENCY STOP mechanisms must remain effective throughout all modes and states of operation.
- Connection cables (particularly data transmission cables) must be selected and laid in a way that ensures that capacitive and inductive interference will not have any adverse effect on the equipment. Appropriate measures must be taken to handle line interruptions to prevent any undefined states occurring.
- Wherever malfunctioning can cause material damage or personal injuries, additional external safety circuits must be provided (e.g. limit switch, mechanical interlocking devices etc.).

## 7.7 Rear panel overview

Illustration 14: Smart HMI unit sample picture

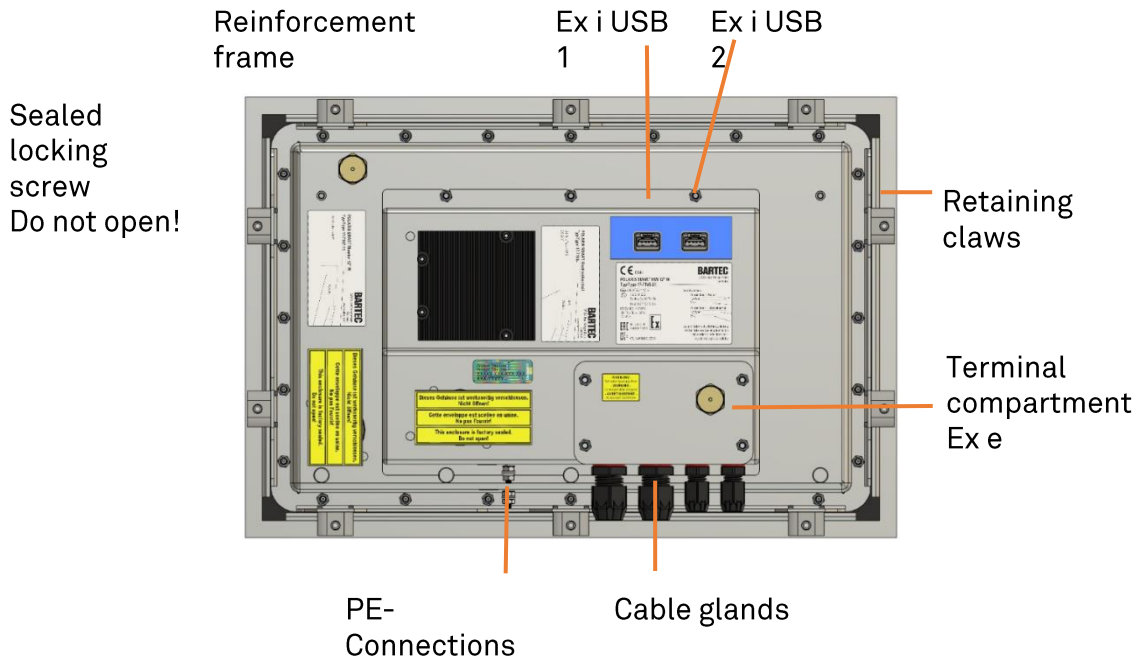

### **⚠ DANGER**

**Sealed locking screw! The device is closed in the factory.  
The explosion protection is lost if opened, and danger to life exists in  
an explosive atmosphere!**

- ▶ Do not open the locking screw!

### **⚠ DANGER**

**Non-certified cable glands and non-sealed cable entries endanger the  
IP protection and accordingly the protection against explosions.**

**There is a risk of fatal injury in an explosive atmosphere!**

- ▶ Use Ex-certified cable glands.
- ▶ Close non-sealed cable entries.

### **⚠ DANGER**

**Terminal compartment is not closed properly with the terminal compartment lid.**

**There is a risk of fatal injury in an explosive atmosphere!**

- ▶ Close the terminal compartment with the terminal compartment lid properly!

## 7.8 PE conductor connection

### DANGER

**Death or danger of injury as a result of no PE conductor connection.**

**There is no explosion protection.**

- ▶ Equipotential bonding with a core cross-section of at least 4 mm<sup>2</sup> is to be set up for the POLARIS (see Figure).
- ▶ Secure PE conductor connections against self-loosening.

**Stainless steel enclosure**

- ▶ Attach equipotential bonding to the enclosure.
- ▶ All moving parts must be earthed.

Illustration 15: PE conductor connection

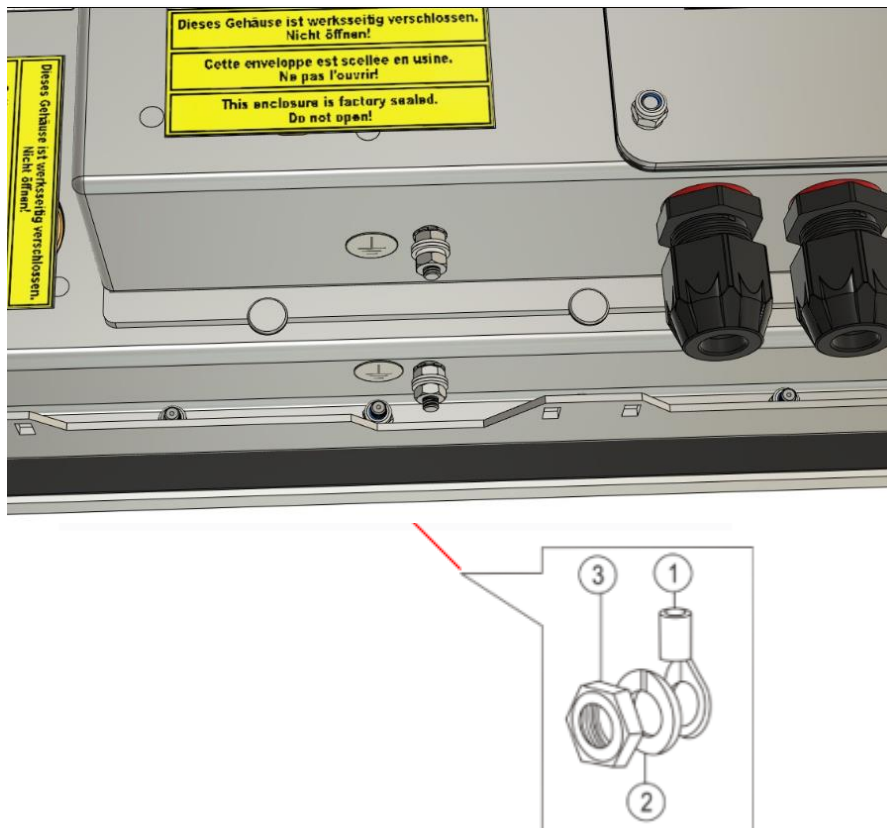

### Work steps:

- Push the PE wire (min. 4 mm<sup>2</sup>) with PE cable lug (1) onto the earthing bolt.
- Position spring washer (2) on threaded bolt and secure with hexagonal nut M4 (3), max. torque: 2.9 Nm.
- Lay cable close to enclosure so that it cannot become loose.

**ATTENTION**

**Device can be damaged by differences in potential!**

- ▶ Avoid differences in potential

## 7.9 Ex e terminal compartments

### 7.9.1 Cable entries

When connecting cables and leads to supplies / communications equipment in increased safety protected areas, Ex certified cable entries must be used which are suitable for each type of cable and lead. You must maintain the protection concept "e" and include a suitable sealing element so that an IP rating of at least IP 64 is maintained.



The terminal area of the M20 cable glands is printed on the cable glands.

A different terminal area may only be substituted with a cable gland that complies with the current version of the approval. The assembly instructions and installation conditions for the cable glands must be observed.

Tightening torque of the cable glands:

Torque	Connecting thread	Nut
non-armoured cables	2,3 Nm	1,5 Nm
armoured cables	8 Nm	5 Nm

**DANGER**

**Do not connect cables and leads when the power supply is active.**

**Danger to life exists in an explosive atmosphere!**

- ▶ Disconnect the device before starting work.
- ▶ Only use certified cable glands that have been approved for the cable diameter of the connection cable.
- ▶ Unused cable glands must be sealed using an approved blanking plug.

### 7.9.2 Terminal Assignment Supply voltage

Mains Connection Variant DC 24 V			
Terminal	Interface	Signal	Remarks
1	Supply	+	DC 24 V ± 10 %
2	Supply	-	GND
3	Supply	PE	Protective earth

### 7.9.3 Terminal Assignment Ethernet

Configuration Ethernet			
Terminal	Interface	Signal	Remarks
4	Ethernet	RxD +	100/10 BaseT Receive positive
5	Ethernet	RxD -	100/10 BaseT Receive negative
6	Ethernet	TxD +	100/10 BaseT Transmit positive
7	Ethernet	TxD -	100/10 BaseT Transmit negative

Clip the cable shield into the shield clamp:

#### Assignment RJ45 plug for Ethernet to POLARIS terminal block





Connection RJ45		POLARIS
PIN	Signal	Terminal
1	TX +	4
2	TX -	5
3	RX +	6
4	n.c	
5	n.c	
6	RX -	7
7	n.c	
8	n.c	

### 7.9.4 Terminal Assignment USB Ex e Interface

Configuration USB		
Terminal	Interface	Signal
8	USB 3	V+
9	USB 3	Data- USB-data signal
10	USB 3	Data+ USB data signal
11	USB 3	V-
12	USB 4	V+
13	USB 4	Data- USB-data signal
14	USB 4	Data+ USB-data signal
15	USB 4	V-



The individual conductors are colour-coded in a 4-wire USB cable as follows:

	<b>Plug Type A</b>	<b>Socket Type A</b>
	4 3 2 1	1 2 3 4
	<b>Plug Type B</b>	<b>Socket Type B</b>
	1 2 4 3	2 1 3 4

Color coded conductors – meaning of colors		
USB connection	Color	Function
1	RD	V+
2	WH	Data- USB-data signal
3	GN	Data+ USB data signal
4	BK	V-



The maximum length of a lead should not exceed 1.5 m.  
Maximum current: 450 mA.

### 7.9.5 2 x Ex i USB-interface

#### ATTENTION

**The Ex i interface has not been designed for USB devices with their own power supply. Damage to nproperty through incorrect use!**

- ▶ Do not connect any USB equipment with its own power supply to the Ex I interface.

#### **USB socket 4-pole, Type A**

Interfaces Ex-i USB 1 and Ex i USB 2

Only admitted accessories are allowed to connect.



The following types of cable should be used for the extension (max. 2 m).

Supported Cable's:

Inline E258105 AWM STYLE 2725, 80°C 30V VW-1

28AWGX1P, 24AWGX2C; USB 2.0 High speed cable

## 7.10 EMC (electromagnetic compability)



This is a class A unit and can cause radio interference in residential areas; if it does, the owner/managing operator may be required to implement suitable measures and pay for loss or damage.



Only shielded conductors may be used as connecting conductors. This applies both to the data line and to all other conductors too. The data lines must be stranded in pairs. Example 2 x 2 x 0.75 mm<sup>2</sup> LIYCY TP. As far as possible, separate conductors should be used for power supply and data.

### 7.10.1 Voltage supply (AC- and DC- variants)

A regulated mains adapter with an output of at least 2 A must be used as power supply. It is not permitted to fall below or exceed the power supply of DC 24 V ± 10 % at the installation site. The voltage drop on the supply line must be observed and corrected where necessary.

The voltage drop on the supply line is calculated according to the following equation:

$\Delta U$	Voltage drop on the supply line at power supply voltage of DC 24 V	Max. 2,4 V
$\Delta U$	Voltage drop on the supply line with maximum permissible mains adapter overvoltage DC 24 V +10 % (26,4 V)	Max. 4,8 V (until 10 % undervoltage is achieved)
$I$	Electricity for a POLARIS	37W / 24V → probably 2 A
$A$	Cable cross-section of the supply line	
$\kappa$	Specific conductance of copper	$56 \frac{m}{\Omega \cdot mm^2}$
$l$	Length of the supply line (consider both the outgoing and return line)	

$$R = \frac{l}{\kappa \cdot A}$$

$$R = \frac{\Delta U}{I}$$

$$\Delta U = \frac{l}{\kappa \cdot A} \cdot I$$

Examples	Cable-cross-section	Maximum line length
Supply voltage DC 24 V	0,75 mm <sup>2</sup>	approx. 25 m
	1,5 mm <sup>2</sup>	approx. 50 m
	2,5 mm <sup>2</sup>	approx. 84 m

In the Sample calculation, the outgoing and return conductors are considered (half cable length)

If the voltage drop cannot be balanced out or the calculation produces excessive cable cross-sections, a separate mains adapter must be installed near the installation site.

Example: pressure-tight encapsulation or ex-free area on the outside of the building.

### 7.10.2 Back-up fuse

The POLARIS SMART HMI with DC 24 V is internally protected by a 2 A fuse. The fuse can trip in the case of voltage drops or undervoltage.

Back-up fuse				
Internal fuse		I <sup>2</sup> value	External fuse	
Siba 2 A T	1500A@250V AC/DC		13 A <sup>2</sup> s	Siba; type 179021 1.6 A 2.0 A F



We recommend protecting the POLARIS with an upstream fuse to prevent blowing the fuse inside the device. Only BARTEC can change the internal fuse.

Back-up fuse DC: 4 A quick-acting.

The I<sup>2</sup> value is to be observed for other versions of the fuses.

### 7.10.3 Interference suppression

Certain basic measures must be taken to ensure freedom from interference when the POLARIS are installed:

- The interference voltages coupled into the device via power, data and signal line and the electrostatic voltage caused by contact are to be dissipated through the equipotential bonding.
- The installation point should be as far as possible away from fields of electromagnetic interference. This is especially important if there are frequency converters in the vicinity. Under certain circumstances will it be advisable to set up partitions to isolate the graphic display from interference.
- If inductive devices are fitted in the vicinity (e.g. contactor, relay or solenoid coils), especially if they are powered from the same source, protective circuits (e.g. RC elements) must be installed.
- Power supply and data cables must be laid so as to avoid interference. This can be achieved, for example, by avoiding laying such cables in close proximity to high-current carrying cables.

### 7.10.4 Shielding

- Only cables with braided shielding should be used (recommended cover density > 80%).
- Sheet shielding should not be used.
- Generally, connection of the shielding at both ends results in optimum damping of all interference frequencies.
- Connection of the shielding at one side only may be more advisable if a difference in potential exists and no equipotential bonding cable can be laid

### 7.10.5 Connection of shielding

A low impedance connection to the circuit protective conductor is important to ensure a low current fault path. When sub-D connectors are used, the shielding should always be connected to the metal casing of the sub-D plug.

The plug casing of some controllers is not always well connected to earth. In such cases it may prove advantageous to insulate the shielding from the sub-D plug of the controller and connect it directly to the protective earth conductor by means of a cable that should be kept as short as possible (0.75 mm<sup>2</sup> ... 1.5 mm<sup>2</sup>).

### 7.10.6 Examples of shielding connections

#### ATTENTION

**Device can be damaged by differences in potential!**

- ▶ Avoid differences in potential.

#### Double-sided shield connection on the connecting cables:

*Illustration 16: Example of double-sided shield connection*

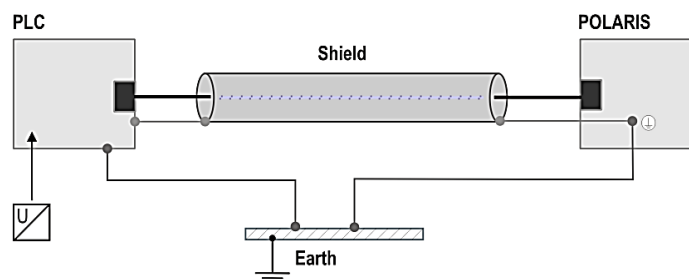

Generally, connection of the shielding at both ends results in optimum damping of all interference frequencies. This method is to be recommended when there is good equipotential bonding between the individual units. In such cases it is possible to make use of the controller's voltage supply cable even if this is not electrically isolated.

### Single-sided shield connection on the connecting cables:

*Illustration 17: Example of double-sided shield connection*

*Illustration 18: Example of single-sided shield connection*

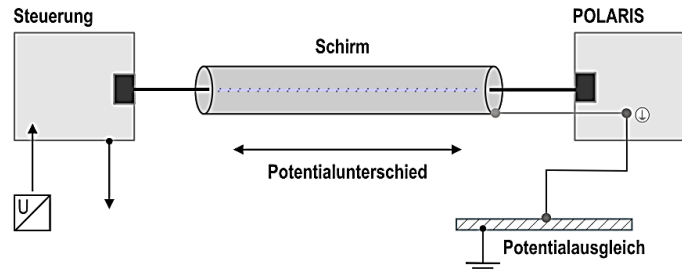

Connection of the shielding at one end only is recommended when there is inadequate equipotential bonding, or none at all. In such cases an electrically isolated power supply unit must be used. Before the equipment goes into service the directions from the controller manufacturer regarding proper assembly and operation must be read carefully. They should then be applied taking full account of the recommendations we make here.

## 8 On-Screen-Display

### 8.1 Control buttons

The POLARIS SMART HMI 12" W has 5 control buttons, which have different functions.

*Illustration 19: Control buttons*

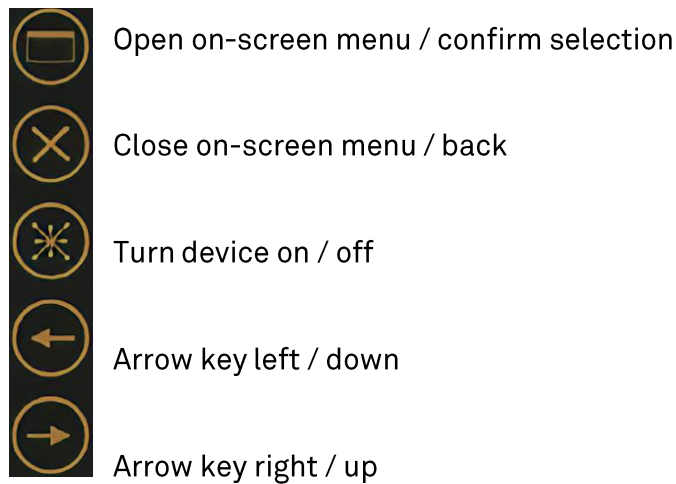

### 8.2 Unlocking the operating keys

The operating keys must first be enabled so that further functions are possible, and settings can be made via the on-screen menu.

To unlock, press the keys



and



Together for more than 5 seconds.

Now the keys are unlocked, and the functions as described in points **8.3** and **8.4** are possible.

The display does not give any feedback once the keys have been activated!

If no more operating keys are pressed within 20 seconds, the control panel locks again and must be unlocked again by pressing the two keys.

## 8.3 Turning on / off

### 8.3.1 Turn display on / off

To turn on or to turn off the display, the button



**Turn device on**

Must be pressed for a short moment and must be released again. A signal is sent to the graphics card, which turns it on.

This does not affect the computer, which stays on or off.

The green and red light-emitting diodes provide the following feedback:

Green LED	Red LED	Status
On	On	Display is on and in sleep or power save mode.
On	Off	Display is on and running.
Off	On	Display searches for signal. If there is no signal, the display is off after a short time.

Illustration 19: Digital timing diagram - display



#### Note:

Before you can turn the Display on / off, you need to activate the operating buttons

by pressing the keys

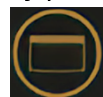

**Open on-screen menu / confirm selection**

and

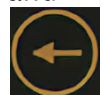

**Arrow key left / down**

Together for more than 5 seconds.

The display does not give any feedback once the keys have been activated!

For more information, see point **8.2**.

### 8.3.2 Turn computer on / off



To turn the computer on or off, you must press and held the button

**Turn device on / off**

for about 15 seconds.

This sends a signal to the computer, which turns it on / off.  
After releasing the button afterwards, a signal is also sent to the graphics card, which turns it on / off.

**Caution:**

This method of switching off should only be used if the computer unit no longer responds or can no longer be operated due to an error.  
This switching off behaves like a loss of power supply and unsaved data can be lost.

The blue light-emitting diode gives the following feedback:

Blue LED	Status
Off	Computer unit or complete device without power supply and therefore off.
Blinking	Power supply is on, but computer unit is off.
On	Computer unit is booting or has been started up.

Illustration 20: Digital timing diagram - computer



**Note:**

Before you can turn the computer on / off, you need to activate the operating buttons by pressing the keys



**Open on-screen menu / confirm selection**

and

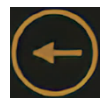

**Arrow key left / down**

Together for more than 5 seconds.











The display does not give any feedback once the keys have been activated!

For more information, see point **8.2**.



## 8.4 On-screen menu

### 8.4.1 Operation of the on-screen menu

- To open the on-screen menu, press the button  
 **Open on-screen menu / confirm selection.**
  
- Choose one of the menu points with the button  
 **Arrowkey Left or Arrowkey**  **right**  
and confirm the selection by pressing the button  
 **Open on-screen menu / confirm selection.**
  
- Choose one of the options with the button  
 **Arrowkey Left or Arrowkey**  **right**  
and confirm the selection again by pressing the button  
 **Open on-screen menu / confirm selection.**
  
- Change the values with the   arrowkeys  
and confirm the selection again by pressing the button  
 **Open on-screen menu / confirm selection.**
  
- To cancel an input in general or to return to the previous point, press the button  
 **Close on-screen menu / back.**

### 8.4.2 Menu PICTURE

Illustration 21: Picture-menu

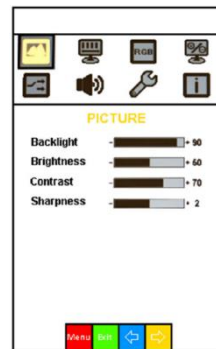

#### Backlight

Controls the brightness of the screen backlight.

#### Brightness

Controls the brightness of the screen by adjusting the pixel color value.

#### Contrast

Controls the contrast of the image displayed on the screen.

Contrast refers to the Y-domain and affects the red, green, and blue values.

#### Sharpness

Controls the sharpness of the image displayed on the screen.

### 8.4.3 Menu DISPLAY

Illustration 22: Display-menu

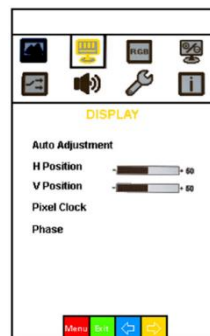

#### H Position

Use this option to adjust the horizontal image position.

#### V Position

Use this option to adjust the vertical image position.

#### Notice:

The horizontal and vertical image positions are optimally set in the delivery state and should not be changed!

#### 8.4.4 Menu COLOR

Illustration 23: Color-Menu

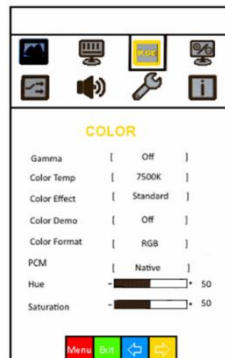

- **Gamma**  
**Pre-set Gamma Correction**
  - o 1.8
  - o 2.0
  - o 2.2
  - o 2.4
  - o **Off** (default)
  
- **Color Temp**
  - o **Off:** (default)
  - o **sRGB:** (for colour matching with sRGB compatible peripherals)
  - o **5800K:** (pre-defined colour temperature scheme)
  - o **6500K:** (pre-defined colour temperature scheme)
  - o **7500K:** (pre-defined colour temperature scheme)
  - o **9300K:** (pre-defined colour temperature scheme)
  - o **User:** user defined adjustment  
**Sub-Menu > USER** – Individual adjustment of R, G and B
  
- **Color Effect**
  - o **Standard:** (pre-defined colour effect scheme)
  - o **Game:** (pre-defined colour effect scheme)
  - o **Movie:** (pre-defined colour effect scheme)
  - o **Photo:** (pre-defined colour effect scheme)
  - o **Vivid:** (pre-defined colour effect scheme)
  - o **User:** user defined adjustment  
**Sub-Menu >USER** – Individual adjustment of Hue and Saturation separately for R Y, G, B, M
  
- **Color Demo:** Shows area with special settings.
- **Color Format**
  - o **RGB:** (default)
  - o **YUV:**
- **PCM:** (TBD)
- **Hue:** Set this in user mode colour effect
- **Saturation:** Set this in user mode colour effect

## 8.4.5 Menu ADVANCE

Illustration 24: Advance-Menu

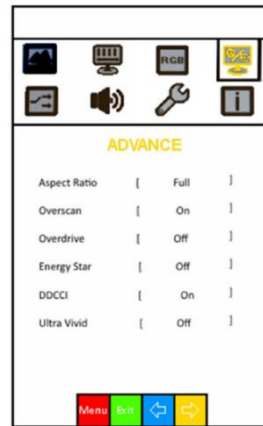

- **Aspect Ratio:**
  - Original
  - Full
  - 16:9
  - 4:3
  - 5:4
- **Overscan**
  - On
  - Off
- **Overdrive:** Off (always)
- **Energy Star:** TBD
- **DDCCI:** Display Data Channel (DDC) / Command Interface (CI)
  - On: Enable external DDCCI access
  - Off: Disable external DDCCI access
- **Ultra Vivid:** (not supported)

### 8.4.6 Menu INPUT

Illustration 25: Input-Menu

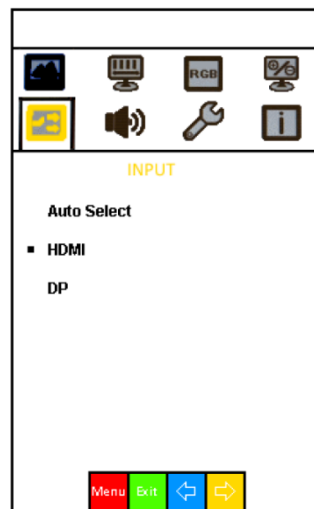

Using this option, one of the connected video sources can be selected.

- **Auto Select:** This option will select the next active video source automatically.
- **HDMI:** The connected HDMI signal will be selected as scaler input.
- **DP:** The connected Display Port signal will be selected as scaler input.

**Notice:**

No image is displayed if a video source is selected that does not provide a signal. As a result, the on-screen display menu is also no longer displayed.

In order to correct the incorrectly selected video source again, after turning on the display, you can press the button



**Arrowkey right**

to open an extra menu in which you can choose the right video source. Auto Select should be selected here, as the video source is detected automatically.

Illustration 26: Video-source select menu

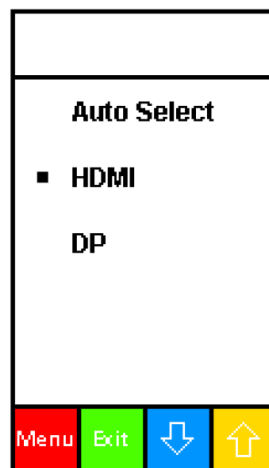

## 8.4.7 Menu OTHER

Illustration 27: Other-Menu

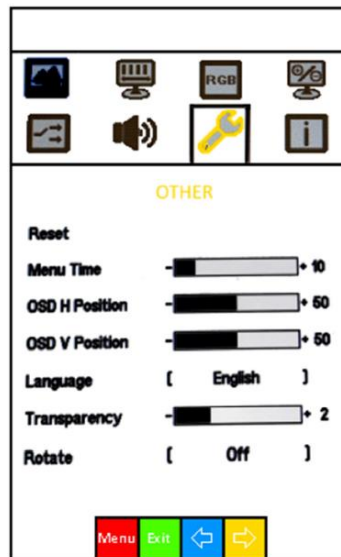

- **Reset:** Select this option to restore the default factory settings.
- **Menu Time:** OSD menu lasting on screen time Defaults to 10s.
- **OSD H Position:** Horizontal start of OSD Menu on screen.
- **OSD V Position:** Vertical start of OSD Menu on screen.
- **Language OSD:** Menu language (English, German, French).
- **Transparency:** Use this option to adjust transparency of the active OSD.
- **Rotate**
  - **Off:** Shows OSD menu in upright position.
  - **On:** Shows OSD Menu 90° counterclockwise.

#### 8.4.8 Menu INFORMATION

Illustration 28: Information-Menu



The information menu shows:

- Current Mode
- Horizontal and vertical frequencies
- Pixel clock
- Part number
- Firmware date

## 9 Commissioning

For electrical systems the relevant installation and operating specifications (e.g. Directives 2014/34/EU, BetrSichV and the applicable national ordinances, IEC 60 079-14 and the DIN VDE 0100 series) must be observed.

The operator of an electrical system in a hazardous environment must keep the operating equipment in an orderly condition, operate it correctly, monitor it and do the required maintenance and repairs.

Before commissioning the devices, check that all components and documents are there.

### 9.1 Final inspection

**Check the following requirements before commissioning the device:**

Only open the Ex e terminal compartment with terminals for the supply and data line(s) once it has been ensured that no potentially explosive atmosphere is present and that the power supply has been turned off.

- Has the reinforcement frame between the bracket and enclosure been inserted?
- Is there no damage to seals, cable connections or glass panel?
- Are the supply and data line(s) correctly wired?
- Is the PE connection correctly earthed?
- Are the supply and data line(s) firmly connected in spring-loaded terminals?
- Are all terminal compartments closed?
- Are all open cable glands closed with sealing plugs?

Only start the POLARIS (if a potentially explosive atmosphere is present) once the final inspection has been carried out.



## 10 Declaration of conformity

EU Konformitätserklärung  
EU Declaration of Conformity  
Déclaration UE de conformité  
N° 11-71V0-7C0001-E

**BARTEC**

Wir	We	Nous
	<b>BARTEC GmbH</b> Max-Eyth-Straße 16 97980 Bad Mergentheim Germany	
erklären in alleiniger Verantwortung, dass das Produkt <b>Visualisierungseinheit POLARIS</b>	declare under our sole responsibility that the product <b>Visual Unit POLARIS</b>	attestons sous notre seule responsabilité que le produit <b>Unité visuelle POLARIS</b>
	Typ: 17-71V0-****/**** Typ: 17-71V1-****/**** Typ: 17-71V2-****/**** Typ: 17-71V3-****/**** Typ: 17-71V6-****/**** Typ: 17-71VZ-****/****	
auf das sich diese Erklärung bezieht den Anforderungen der folgenden <b>Richtlinien (RL)</b> entspricht <b>ATEX-Richtlinie 2014/34/EU</b> <b>EMV-Richtlinie 2014/30/EU</b> <b>RoHS-Richtlinie 2011/65/EU</b> <b>RED-Richtlinie 2014/35/EU</b> und mit folgenden Normen oder normativen Dokumenten übereinstimmt	to which this declaration relates is in accordance with the provision of the following <b>directives (D)</b> <b>ATEX-Directive 2014/34/EU</b> <b>EMC-Directive 2014/30/EU</b> <b>RoHS-Directive 2011/65/EU</b> <b>RED-Richtlinie 2014/35/EU</b> and is in conformity with the following standards or other normative documents	se référant à cette attestation correspond aux dispositions des <b>directives (D)</b> suivantes <b>Directive ATEX 2014/34/UE</b> <b>Directive CEM 2014/30/UE</b> <b>Directive RoHS 2011/65/UE</b> <b>Directive RED 2014/35/UE</b> et est conforme aux normes ou documents normatifs ci-dessous
EN IEC 60079-0:2018 EN 60079-1:2014 EN 60079-5:2015 EN 60079-7: 2015/A1:2018 EN 60079-11:2012 EN 60079-18: 2015 /A1:2018 EN 60079-28:2015 EN 60079-31:2014 EN 61000-3-2:2014 EN 61000-3-3:2013	EN 61000-6-2:2019 EN 61000-6-4:2019 EN 60950-1:2006/ A2:2013 EN 62311:2008 EN 62479:2010 EN 62368-1:2014/A11:2017 EN 55024:2010+A1:2015 EN 55032:2015/AC:2016 EN 55035:2017/A11:2020 EN 300 328 V2.2.2	
Eine Übereinstimmung mit den aufgeführten Normen ist variabel und abhängig vom spezifischen Typen.	A conformity with the listed standards is variable and depends on the specific type.	La conformité aux normes citées est variable et dépend du type spécifique.
Verfahren der EU-Baumusterprüfung / Benannte Stelle	Procedure of EU-Type Examination / Notified Body	Procédure d'examen UE de type / Organisme Notifié

IBExU 05 ATEX 1117 X Issue 3

0637, IBExU, Fuchsmühlenweg 7, 09599 Freiberg, DE

**CE** 0044

Bad Mergentheim, 07.10.2022

*i.v. Reiner Englert*  
i.V. Reiner Englert  
Product Manager Automation

*S. Steffen*  
i.A. Steffen Mika  
Certification Manager R&D ESS



UK Declaration of Conformity

Nº 11-71V0-7CU001

We

**BARTEC GmbH**  
Max-Eyth-Straße 16  
97980 Bad Mergentheim  
Germany

declare under our sole  
responsibility that the product

**POLARIS series**

Typ: 17-71V0-\*\*\*\*/\*\*\*\*  
Typ: 17-71V1-\*\*\*\*/\*\*\*\*  
Typ: 17-71V2-\*\*\*\*/\*\*\*\*  
Typ: 17-71V3-\*\*\*\*/\*\*\*\*  
Typ: 17-71V6-\*\*\*\*/\*\*\*\*  
Typ: 17-71VZ-\*\*\*\*/\*\*\*\*

to which this declaration relates is in accordance with the provision of the following regulations

Statutory Instrument 2016 No. 1107 - The Equipment and Protective Systems Intended for Use in Potentially Explosive Atmospheres Regulations 2016  
Statutory Instrument 2016 No. 1091 - The Electromagnetic Compatibility Regulations 2016  
Statutory Instrument 2017 No. 1206 - The Radio Equipment Regulations 2017  
Statutory Instrument 2012 No. 3032 - The Restriction of the Use of Certain Hazardous Substances in Electrical and Electronic Equipment Regulations 2012

and is in conformity with the following standards or other normative documents

<b>EN IEC 60079-0:2018</b>	<b>EN 61000-6-2:2019</b>
<b>EN 60079-1:2014</b>	<b>EN 61000-6-4:2019</b>
<b>EN 60079-5:2015</b>	<b>EN 60950-1:2006/ A2:2013</b>
<b>EN 60079-7: 2015/A1:2018</b>	<b>EN 62311:2008</b>
<b>EN 60079-11:2012</b>	<b>EN 62479:2010</b>
<b>EN 60079-18: 2015 /A1:2018</b>	<b>EN 62368-1:2014/A11:2017</b>
<b>EN 60079-28:2015</b>	<b>EN 55024:2010+A1:2015</b>
<b>EN 60079-31:2014</b>	<b>EN 55032:2015/AC:2016</b>
<b>EN 61000-3-2:2014</b>	<b>EN 55035:2017/A11:2020</b>
<b>EN 61000-3-3:2013</b>	<b>EN 300 328 V2.2.2</b>

A conformity with the listed standards is variable and depends on the specific type.

Procedure of UK-Type Examination / Approved Body

**IBExU 05 ATEX 1117 X Issue 3**  
**0637, IBExU, Fuchsmühlenweg 7, 09599 Freiberg, DE**

## 11 Labelling – POLARIS SMART HMI

Illustration 20: SMART HMI unit sample picture

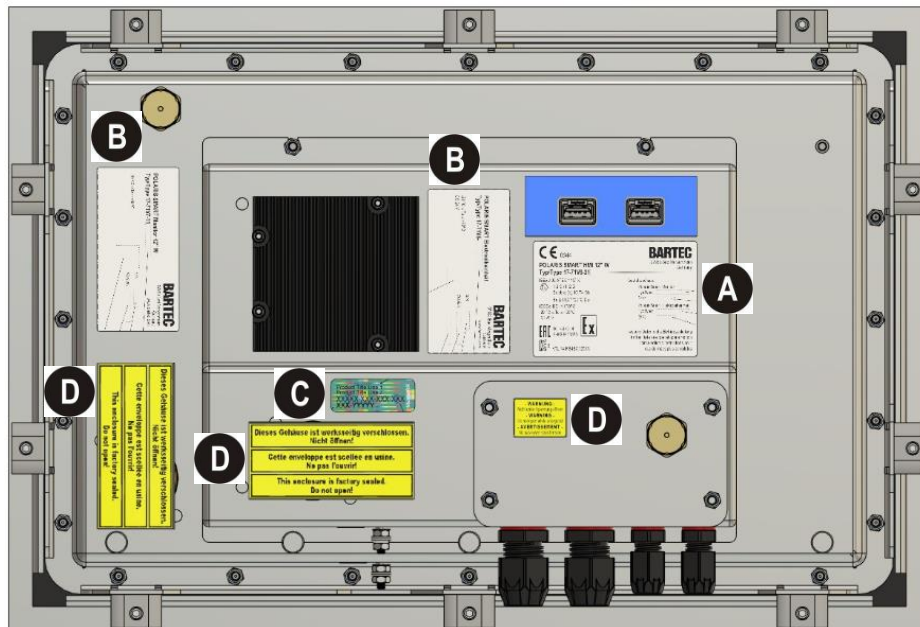

### Labelling

**A**  
Ex Type label

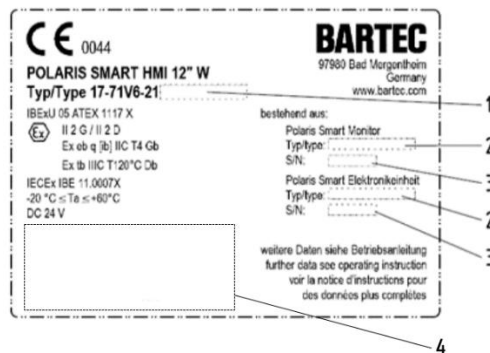

- 1 - Type number according to the production order
- 2 - Type number Monitor / Electronic Unit
- 3 - Year of manufacture / serial number
- 4 - Certifications

**B**  
Type label for Polaris  
SMART Monitor /  
Electronic Unit

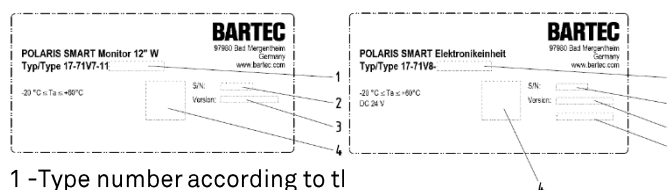

- 1 - Type number according to tl
- 2 - Year of manufacture / serial number
- 3 - Revision
- 4 - Data matric code with serial number

**C**  
Licence sticker

depending on the operating system



Warnings on the device

